



NSW GOVERNMENT
Department of Planning

DEVELOPMENT NEAR RAIL CORRIDORS AND BUSY ROADS – INTERIM GUIDELINE



Development Near Rail Corridors and Busy Roads – Interim Guideline
ISBN 978-0-7347-5504-9
© The State Government of NSW through the
Department of Planning 2008
www.planning.nsw.gov.au
DoP 08_048

Disclaimer: While every reasonable effort has been made to ensure that this document is correct at the time of printing, the State of New South Wales, its agents and employees, disclaim any and all liability to any person in respect of anything or the consequences of anything done or omitted to be done in reliance upon the whole or any part of this document.

Part A: Introduction

1	Introduction	1
1.1	Overview	1
1.2	Application of the Guideline and its relationship to the Infrastructure SEPP	1
1.3	What development does the Guideline apply to?	3

Part B: Strategic Planning Context

2	Linkages with the government's strategic landuse planning initiatives	5
2.1	Overview	5
2.2	Transport corridors in the urban context	6
2.3	Landuse near railway stations	7
2.4	Site selection for sensitive development	8
2.4.1	Housing	8
2.4.2	Educational establishments and child care centres	9
2.4.3	Other sensitive uses such as hospitals, seniors housing and places of worship	10

Part C: Development impacted by rail corridors and busy roads

3	Noise and vibration	11
3.1	Introduction	11
3.2	Health implications of noise	11
3.3	When is noise and vibration likely to be an issue	12
3.4	What noise and vibration concepts are relevant?	12
3.5	When is an acoustic assessment needed?	13
3.5.1	Rail corridors	15
3.5.2	Busy Roads	16
3.6	What noise and vibration criteria should be applied	19
3.6.1	Airborne Noise	19
3.6.2	Ground borne noise	20
3.6.3	Vibration criteria	20
3.7	What a noise assessment report should contain	20
3.7.1	Seeking early advice	20
3.7.2	The acoustic assessment	20
3.8	Avoiding airborne noise and vibration impacts by good design	21
3.8.1	Subdivisions and new land release	21
3.8.2	Building location, design orientation and room layout	21
3.8.3	Buildings as noise shields	23
3.8.4	Podiums, balconies and courtyards	25
3.8.5	Noise Barriers, Mounds and Screens	26
3.8.6	Building treatments	30
3.8.7	Design to minimise adverse vibration and ground-borne noise impacts	32
4	Air Quality near busy roads	33
4.1	Health implications from motor vehicle air emissions	33
4.2	Influences on air quality	33
4.3	When is air quality likely to be an issue?	33
4.3.1	Outdoor air circulation – wind and breezes	33
4.3.2	Emission levels and proximity to carriageway	34
4.4	Mitigation levels	35
4.4.1	Ventilation of indoor areas	35
4.4.2	Design considerations	35

Part D: Potential impact of adjacent development on roads and railways

5	Safety and Design Issues	36
5.1	Essential early requirements	36
5.1.1	Safe design practices	36
5.1.2	Early consultation with road and rail authorities	36
5.1.3	Survey Information	36
5.2	Electrolysis	36
5.2.1	Why is electrolysis an issue?	36
5.2.2	Avoiding or minimising electrolysis damage	37
5.3	Cranes	38
5.3.1	Specific requirements for cranes and other aerial equipment in the rail corridor	38
5.4	Safe access for maintenance	38
5.5	Stormwater management	38
5.6	Vandalism	39
5.7	Graffiti	39
5.8	Lighting, external finishes and design	39
5.9	Structures in the rail corridor	40
5.10	Derailment protection of structures	40
5.11	Electrocution - overhead wiring	40
5.12	Underground electrical services	41
5.13	Track closures, power outages and corridor access	41
5.14	Level crossings	41
5.14.1	Planning considerations for Level Crossings	42
5.15	Fencing	42
6	Excavation, earthworks and other construction related issues	43
6.1	Introduction	43
6.2	When are excavations and earthworks likely to be a key issue	44
6.2.1	Excavations and other earthworks adjacent to road and rail corridors	44
6.2.2	Excavations and other earthworks above tunnels	45
6.3	Avoiding impacts by good planning and design	46
6.4	When is an assessment needed	46
6.5	What are the assessment requirements	46
6.5.1	General	46
6.6	Typical excavation and earthworks management issues	48
6.6.1	Benching or battering	48
6.6.2	Excavation support systems	49
6.7	Typical site construction and post construction issues	51
6.7.1	Excavations and earthworks	51
6.7.2	Excavation support systems	52
6.7.3	Structures	52
6.7.4	Rail track closure and power outages	52
6.7.5	Demolition	52
	Appendices	53
	Appendix A: Rail Sample Corridor Conditions	53
	Appendix B: Acoustic Planning Measures	57
	Appendix C: Acoustic Treatment of Residences	63
	Appendix D: Acoustic Consultant Reports, Methodology for Testing and Compliance Reporting	69
	References	72

Part A: Introduction

1 Introduction

1.1 OVERVIEW

Major roads and rail operations generate noise and vibration, and people living and working near major transport corridors can be adversely affected. In addition, major roads can impact on air quality due to the volume of traffic they carry.

An aim of the Guideline is to assist in reducing the health impacts of rail and road noise and adverse air quality on sensitive adjacent development.

Development near rail corridors and busy roads can impact on the structural integrity of the transport infrastructure and its engineered structures. Poorly designed and implemented earthworks can cause subsidence, deterioration of existing structures, alter existing loading profiles on tunnels and other engineered features and, in a worse case scenario, cause structural failures and collapse. For electric railways there are significant additional safety issues associated with risks of electrocution as well as risks related to the accelerated corrosive effects of electrolysis on metal surfaces.

The Guideline assists in the planning, design and assessment of development in, or adjacent to, rail corridors and busy roads.

It supports specific rail and road provisions of the State Environmental Planning Policy (Infrastructure) 2007 (the 'Infrastructure SEPP'). The key objectives of these provisions are to:

- protect the safety and integrity of key transport infrastructure from adjacent development; and
- ensure that adjacent development achieves an appropriate acoustic amenity by meeting the internal noise criteria specified in the Infrastructure SEPP.

1.2 APPLICATION OF THE GUIDELINE AND ITS RELATIONSHIP TO THE INFRASTRUCTURE SEPP

The Infrastructure SEPP commenced on 1 January 2008 to facilitate the effective delivery of infrastructure across the State. One of the aims of the Infrastructure SEPP is to identify matters to be considered in the assessment of development adjacent to particular types of infrastructure.

More specifically, the Infrastructure SEPP refers to guidelines which must be taken into account where development is proposed in, or adjacent to, specific roads and railway corridors under clauses 85, 86, 87, 102 and 103 (see page 2). This Guideline fulfils that purpose. For certain development near rail corridors, the Infrastructure SEPP also prescribes a requirement for concurrence from the rail authority, including specific matters that it must take into account before deciding whether to provide concurrence.



Infrastructure SEPP

These guidelines must be taken into account for development under the following clauses (refer to SEPP for detail):

Clauses: Rail corridors

Clause 85: any development on land that is in or immediately adjacent to a rail corridor, if the development is:

- a) likely to have an adverse effect on rail safety;
- b) involves the placing of a metal finish on a structure and the rail corridor concerned is used by electric trains, or;
- c) involves the use of a crane in air space above any rail corridor.

Clause 86: any development (other than development to which clause 88 of the Infrastructure SEPP applies) that involves the penetration of the ground to a depth of at least 2m below ground level (existing) on land that is:

- a) within or above a rail corridor; or
- b) within 25m (measured horizontally) of a rail corridor; or
- c) within 25m (measured horizontally) of the ground directly above an underground rail corridor

Note: the consent authority must not grant consent without consulting with the rail authority and obtaining concurrence consistent with clauses 86(2)–(5)

Clause 87:

- Development for any of the following purposes that is on land that is in or immediately adjacent to a rail corridor and the consent authority considers development is likely to be adversely affected by rail noise or vibration:
 - building for residential use
 - a place of public worship
 - a hospital
 - an educational establishment or childcare centre

In other circumstances (eg. development adjacent to a road with an annual average daily traffic volume of 20,000–40,000 vehicles) these guidelines provide best practice advice.

Clauses: Road Corridors

Clause 102: development for any of the following purposes that is on land in or adjacent to a road corridor for a freeway, a tollway or a transit way or any other road with an annual average daily traffic volume of more than 40,000 vehicles (based on the traffic volume data available on the website of the RTA) and that the consent authority considers is likely to be adversely affected by road noise or vibration:

- building for residential use
- a place of public worship
- a hospital
- an educational establishment or childcare centre

Clause 103: any development which involves penetration of the ground to a depth of at least 3m below ground level (existing) on land that is the road corridor of roads or road projects as specified in schedule 2 of the SEPP.

***For Clauses 87 (Rail) and 102 (Road):**

- If the development is for the purpose of a building for residential use, the consent authority must be satisfied that appropriate measures will be taken to ensure that the following LA_{eq} levels are not exceeded:
 - in any bedroom in the building : 35dB(A) at any time 10pm–7am
 - anywhere else in the building (other than a garage, kitchen, bathroom or hallway): 40dB(A) at any time.



1.3 WHAT DEVELOPMENT DOES THE GUIDELINE APPLY TO?

The Guideline is primarily for consent/approval authorities and proponents (both private and public) and for their designers, architects, project managers, engineers and contractors involved with new residential and other developments alongside railway corridors and busy roads.

The Guideline applies to development adjacent to rail corridors and busy roads. While consideration of the Guideline is a requirement for development specified under the *Infrastructure SEPP* it can also provide a useful guide for all development that may be impacted by, or may impact on, rail corridors or busy roads:

Busy road: defined as

- **Roads specified in Clause 102** of the *Infrastructure SEPP*: a freeway, tollway or a transitway or any other road with an average annual traffic (AADT) volume of more than 40,000 vehicles (based on the traffic volume data provided on the website of the RTA).
- **Any other road** – with an average annual daily traffic (AADT) volume of more than 20,000 vehicles (based on the traffic volume data published on the website of the RTA)
- **Any other road** – with a high level of truck movements or bus traffic.

Rail corridor: as defined by clause 78 of the *Infrastructure SEPP*.

- Land that is owned, leased managed or controlled by a public authority for the purpose of a railway or rail infrastructure facilities, or
- Land that is zoned under an environmental planning instrument predominantly or solely for the development for purpose of a railway or rail infrastructure facilities, or
- Land in respect of which the Minister has granted approval under Part 3A or (before its repeal) Division 4 of Part 5 of the Act for the carrying out of development (or for a concept plan for a project comprising or including development) for the purpose of a railway or rail infrastructure facilities.

Structure of the Guideline

Part A Introduction: (Section 1 – this section) includes the purpose and aim of the guideline and a discussion on the relationship of *the Guideline* to the *Infrastructure SEPP*.

Part B Strategic planning context: (Section 2) contains general guidance for council strategic planning purposes, and also for other government agencies or private proponents investigating possible locations for residential development, places of worship, hospitals, child care centres and schools. It also provides guidance on site selection to reduce or avoid the need for mitigation measures.

Part C Potential impacts of roads and railways on adjacent development: contains information on development that may be impacted by rail corridors and busy roads.

- It applies specifically to new residential and other sensitive developments (or replacement or alterations and additions that require development approval) such as single/dual occupancy and multi-unit dwellings (including residential aged-care facilities), places of public worship, hospitals and educational establishments (including schools and child care centres).
- It addresses specific *Infrastructure SEPP* requirements for noise and vibration (Section 3) (refer to *Infrastructure SEPP* for specific clauses 87, 102), and also provides information on air quality specific to roads (Section 4).

Part D Potential impacts of adjacent development on roads and railways: contains information on development that may impact on rail corridors and busy roads.

- It applies to any development that could have an adverse effect on the safety and/or integrity of the road or rail infrastructure. There are many inherent dangers or risks associated with working within a rail or busy road corridor including safety and signalling systems, high voltage cables and overhead wiring, and movements of heavy vehicles.
- It addresses specific *Infrastructure SEPP* requirements about safety and design (Section 5) and excavation and other earthworks (Section 6) (refer to *Infrastructure SEPP* for specific clauses 85, 86, 103).

Appendices are also attached and are referred to at relevant points throughout the document and contain more detailed or specific information.

Checklist

Section	Title	When is this section relevant?
1	Introduction	Provides an overview of why the Guidelines are relevant and to which development they specifically apply
2	Linkages with the government's strategic landuse planning initiatives	Contains general guidance for council strategic planning, and for government or non-government proponents investigating potential development locations
3	Noise and vibration	When considering whether an acoustic assessment is required and whether noise and vibration mitigation measures are needed
4	Air quality	When considering how to address air quality issues for development near rail corridors and busy roads
5	Safety and design issues	When considering specific safety and design issues for development near rail corridors and busy roads
6	Excavation, earthworks and other construction related issues	When considering any excavation, earthworks, demolition or construction near rail corridors and busy roads

Appendix	Title	What does this Appendix do?
A	Sample Rail Corridor conditions	Provides examples of conditions of consent that may apply to development near or within the rail corridor
B	Acoustic planning measures	Demonstrates the level of noise reduction that can be achieved by acoustically planned dwellings
C	Acoustic treatment of residences	Explains the 'deemed to comply' dwelling construction for each category of noise treatment
D	Acoustic consultant reports: methodology for testing and compliance reporting	Outlines what needs to be included in an acoustic assessment and an acoustic assessment report

Part B: Strategic planning context

This Part of the Guideline contains guidance for council strategic planning purposes, and also for other government agencies or private proponents investigating possible locations for development

2 Linkages with the government's strategic landuse planning initiatives

2.1 OVERVIEW

The Guideline links with key strategic planning documents and a number of initiatives, and is expected to contribute to meeting objectives and priorities in the *State Plan – A New Direction for NSW* (The State Plan). The State Plan defines overarching goals and outcomes that the government considers should shape public policy for the next 10 years.

Meeting State Plan objectives and priorities:

Delivering better services

- S6 – Increasing share of peak hour journeys on a safe and reliable public transport system
- S7 – safer roads

Environment for living

- E3 – cleaner air and progress on greenhouse gas emissions
- E5 – improved urban environment with jobs closer to home.
- E7 – improving the efficiency of the road network

An important feature of strategic planning is the integration of land uses and transport, with a key principle of locating activities, jobs and services in accessible locations close to public transport. Locating new housing and jobs in or near centres will also help reduce the distances people travel and provide additional opportunities for using more sustainable modes of transport such as walking, cycling and public transport.

As part of taking a strategic planning approach, noise and air quality issues should be considered at the strategic level to avoid or minimise the need to address them at the site specific stage. For example, site selection and consideration of site layout and urban form can assist in reducing adverse health impacts from motor vehicle emissions. Similarly considering traffic noise issues upfront at the site selection and design stage is essential for residential, hospitals, childcare centres, schools, places of worship and other sensitive development.

The land use strategies for transport corridors and centres are all important components of the Government's suite of planning initiatives to meet the priorities in the State Plan, including:

- providing places and locations for services, commercial and business activities and a range of other employment and economic activity
- increasing densities and clustering business and other activities in strategic centres
- increasing public transport use and improving liveability.

2.2 TRANSPORT CORRIDORS IN THE URBAN CONTEXT

Residential development often occurs along busy roads. In some cases, it is historical, the houses were there when the road was a minor road, things changed and now the road is a major arterial road servicing the area or region. In other cases, it may have been developed there because of the demand for housing close to a centre, services or public transport. In other cases, it may have been the low land costs which attracted the development. In all cases, the quality of life of the residents can be adversely affected unless appropriate site layout, design or other mitigation measures to minimise noise and air quality impacts have been integrated into the development.

There are a number of other planning considerations relevant to development along busy roads that also need to be considered such as:

- overall visual amenity and
- the design of parking, including the use of slip roads, rear lanes and shared access ways to car parks.

Shops, warehouses and showrooms can often provide a valuable buffer between the busy road and adjacent residential and other noise and air sensitive uses. As a result, it is preferable if residential uses are not carried out along a busy road unless it is part of a development which includes adequate noise and air quality mitigation.

It is also important that centres are developed in a manner that minimises adverse noise and air pollution while also meeting the other objectives for these centres. **Figures 2.1 to 2.2** illustrate how centres near busy roads can be designed to avoid adverse noise and air quality impacts on nearby residential and other noise-sensitive development.

Where communities are already divided by a busy road (**figure 2.2**), it may be preferable to develop two separate centres. This can be a positive outcome with both centres evolving their own identity and level of self-sufficiency. Whether one centre or two, they benefit from improved liveability and amenity.

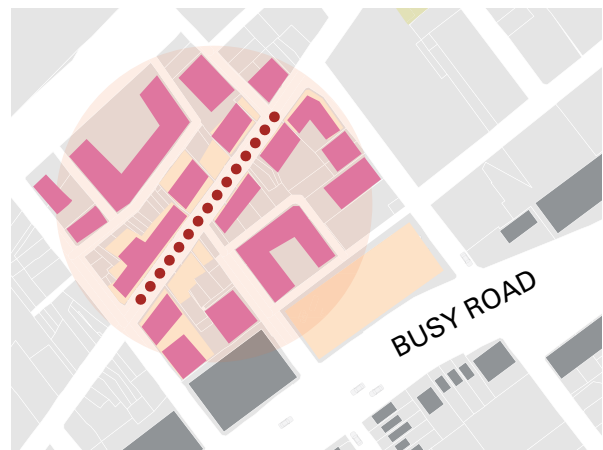

Figure 2.1: An example of a centre on a parallel street near a major traffic route. The “main street” of the centre is on a secondary street rather than the busy road has the potential for a more liveable centre.



Figure 2.2: Village evolving into two centres

A ring road network which encircles a centre can take traffic pressure off the main business district. Examples include ring roads at Maitland, Bondi Junction and Blacktown. Bypasses can perform a similar function in rural areas. The reduction in through-traffic and particularly heavy vehicles makes a more pedestrian friendly environment with benefits for noise amenity, air quality and safety.

2.3 LANDUSE NEAR RAILWAY STATIONS

With increasing residential densities and business activities near rail corridors, there is a growing need to better integrate landuse and transport. This particularly applies to major development near railway stations.

Locating affordable housing and concentrating business activities near stations improves accessibility and opportunities for increased rail patronage. This is particularly the case where the housing or business is within easy walking distance

from the station. Where there are transport nodes such as Chatswood or Bondi Junction, there are also benefits from bus/rail interchanges which contribute to increases in overall public transport use.

Where major developments are proposed near railway stations, proponents are encouraged to consult with councils, rail authorities and the Department of Planning early in the development process. There may be opportunities for the promotion of public transport use through, for example, the provision of commuter parking spaces near the station and, at the same time, through upgrades to railway station facilities to accommodate expected increases in rail patronage.

Similarly, where upgrades to rail infrastructure (particularly stations) are planned by State transport agencies, this may provide opportunities for new developments near rail stations which better link with the developments with the public transport network.

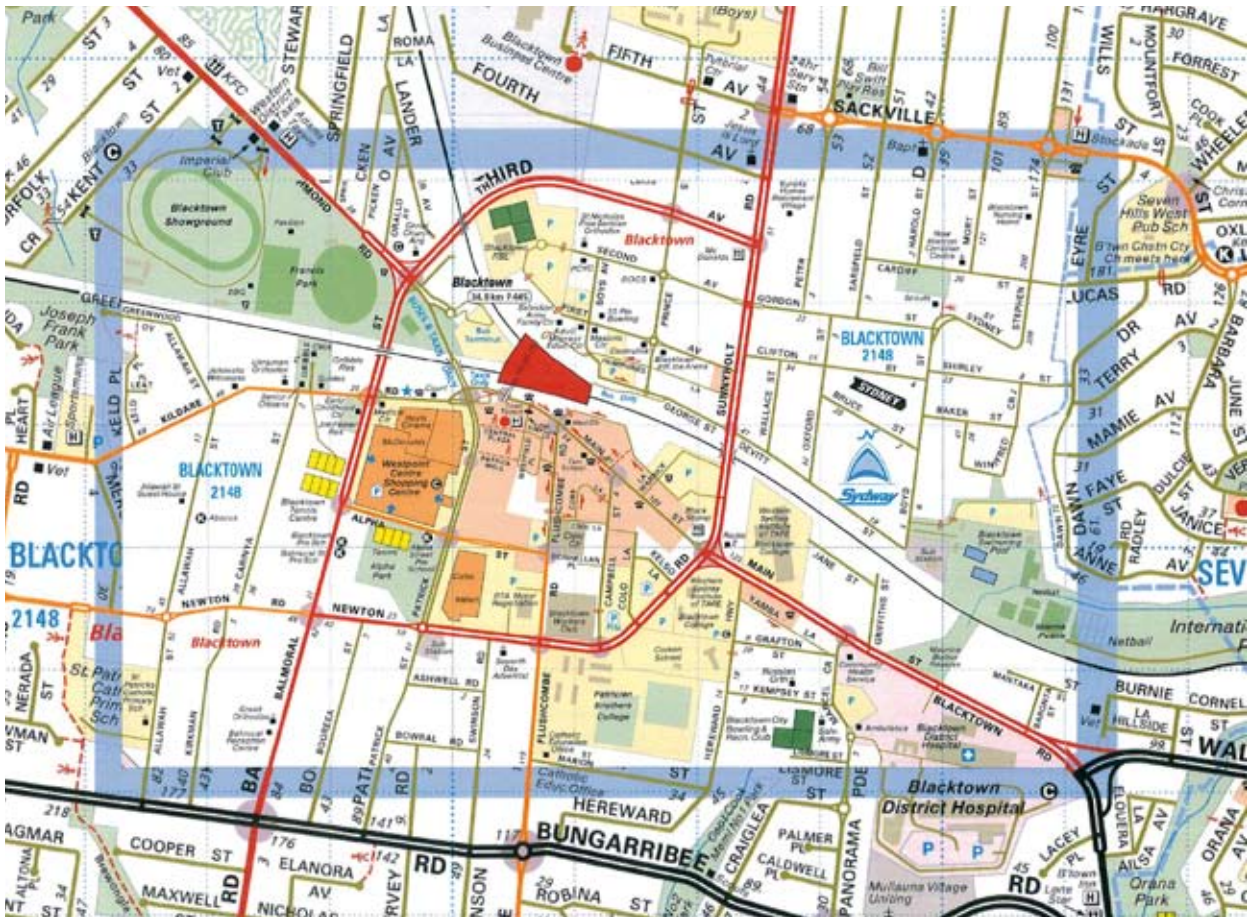

Figure 2.3: Ring road at Blacktown

2.4 SITE SELECTION FOR SENSITIVE DEVELOPMENT

Strategic planning should ensure that residential and other sensitive developments are sited so that the direct impacts of rail corridors and busy roads can be avoided or appropriately managed. By following the strategic planning and design recommendations in this Guideline, the need for mitigation measures at the site planning or building construction stage can be reduced or avoided all together.

Benefits of siting new housing near existing or new centres and rail stations:

- Increased ability to access shops, schools and other services by walking, cycling or using public transport
- Improved environmental, health and social benefits from lower car use
- Improved local planning outcomes with additional housing choice and diversity.

2.4.1 HOUSING

The need to provide environmentally sustainable and affordable housing for a growing population with smaller household sizes will require renewal of existing urban areas.

This should only occur where adverse noise and air quality impacts of the road can be minimised and good quality high amenity residential developments are created.

Ideally, new housing should be located near a centre, within walking distance of frequent public transport and away from direct traffic and adverse noise levels.



2.4.2 EDUCATIONAL ESTABLISHMENTS AND CHILD CARE CENTRES

Strategic site selection from the perspective of road and rail corridors for schools and childcare centres is particularly important as young people are generally more sensitive to the effects of noise and adverse air quality than adults. In addition, very young children and babies are more sensitive to these effects than older children. The childcare day often extends beyond the typical school day to include both morning and afternoon peak hour traffic, making childcare centres particularly vulnerable to adverse noise and air quality effects.

Where new schools and childcare centres are being considered, the design should ensure that there is sufficient separation from 'busy' roads and rail corridors to avoid adverse noise and air quality impacts.

The following diagram illustrates how the strategic location of schools and child care centres can avoid adverse noise and air quality impacts from 'busy' roads.



Figure 2.6: Suggested layout configuration for new childcare centres and schools

Measures to avoid, reduce or mitigate noise and air quality impacts at schools and child care centres include:

- Redesigning or relocating buildings to locate non-sensitive services like storage, bathrooms and carparking in areas subject to noise and air pollution sources
- Creating courtyards or play areas that are protected from noise and adverse air quality by buildings
- Where sufficient land is available, selling some of the road frontage area to enable it to be used for less sensitive land uses, such as shops or businesses
- Constructing solid noise wall barriers along the road frontage, taking into consideration any impacts on amenity, solar access, vegetation and safety.

Another benefit of directing school access to a street with low traffic volume is to reduce the conflict between pedestrian access, drop off areas and high traffic volume, thereby improving road safety. A location on a quieter street within walking distance of public transport and adjacent to other complementary facilities in and around centres is the ideal.

Once a site has been selected, it is important to avoid siting areas where children spend a lot of time (eg classrooms or outdoor recreation areas) close to the road or rail corridor.

Many existing schools are located in urban areas adjacent to rail corridors and busy roads often because the density of urban areas has intensified over time. This is particularly the case in inner city areas and well established 'middle' suburbs. In these circumstances, redevelopment provides the main opportunity for avoiding, reducing or mitigating adverse impacts experienced at the school.

2.4.3 OTHER SENSITIVE USES SUCH AS HOSPITALS, SENIORS HOUSING AND PLACES OF WORSHIP

Other sensitive uses such as hospitals, seniors housing or places of worship should be located to ensure that vulnerable patients, the elderly or people engaged in religious activities are not placed in areas subject to adverse noise and air quality impacts.

Modern hospitals are usually constructed so not to be sensitive to adverse noise and air pollution as they are usually sealed buildings which have been designed to ensure that internal conditions

are suitable for patients. Efficient ambulance access to the road network is very important, often requiring links to a busy road. However, where a hospital is to be naturally ventilated with windows that open and has balcony/outdoor areas, the site layout should ensure that the areas used by patients are suitably separated from rail corridors and busy roads or incorporate design features that mitigate noise and air pollution to acceptable levels.

Similarly, seniors housing or places of worship should be located so as to minimise the effects of adverse noise and air quality on occupants.



Figure 2.7: Suggested layout arrangement for hospitals

PART C: Development impacted by rail corridors and busy roads

This Part contains information on development impacted by rail corridors and busy roads. It addresses the specific Infrastructure SEPP requirements for noise and vibration (Section 3) and provides additional information on air quality (Section 4).

3 Noise and vibration

3.1 INTRODUCTION

Rail operations and busy roads generate noise and vibration.

This Guideline establishes triggers and a process to assess project specific noise levels for residential and other sensitive users as identified in the Infrastructure SEPP. By implementing the Guideline, it is anticipated that an appropriate acoustic amenity can be achieved for development near transport corridors, particularly residential development and other noise sensitive land uses. There may be instances, however, where the proponent or homeowner may choose to have an even greater level of acoustic amenity is required. In these cases, additional acoustic design or mitigation measures may be implemented.

3.2 HEALTH IMPLICATIONS OF ADVERSE NOISE LEVELS

Adverse levels of noise, whether the source is road or rail, rarely causes damage to hearing, but rather has psychological and physiological effects such as fatigue due to sleep deprivation. Although the research into the effects of noise on sleep is limited with varying results, it is generally considered that noise may interfere with sleep in a number of ways:

- awakening – it can cause a person to awaken repeatedly, resulting in poor sleep quality as well as other impacts
- alter sleep pattern – noise may cause sleep to change from heavier to lighter sleep
- reduce the percentage and total time in rapid eye movement (REM) sleep
- affect slow wave sleep
- increase body movement
- change cardio vascular responses

These changes can affect mood and performance the next day and may have longer term effects. This is particularly the case for sensitive groups such as young children where it can decrease their ability to learn and can impact on long-term health. The effects of high levels of noise on child cognition can include:

- reduced attention span;
- difficulties in concentrating;
- poorer discrimination and perception of speech;
- poorer memory of complex spoken information; and
- poorer reading ability and school performance.

Reference sources:

Infrastructure SEPP: rail/road internal residential noise criteria – refer cl. 87, 102 of SEPP and Table 3.1 later in this Guide.

Interim Guidelines for the Assessment of Noise from Rail Infrastructure Projects (DECC 2007): describes the process for the assessment of potential noise impacts associated with new rail developments.

Assessing Vibration: a technical guideline (DECC 2008): describes the process of assessing vibration.

Environmental Criteria for Road Traffic Noise (ECRTN) (EPA 1999): currently under review – contains non-mandatory road traffic noise criteria for residential land use and other sensitive land uses. The Guideline has been developed, partly based on some of the criteria in that document. The ECRTN contains other non-mandatory road traffic noise level criteria that apply to such matters as passive recreation in school grounds. The relevance of these other criteria should be considered when developing plans or assessing development proposals.

3.3 WHEN IS NOISE AND VIBRATION LIKELY TO BE AN ISSUE

The impact of noise and vibration from road or rail infrastructure can vary considerably depending on site characteristics and layout, as well as surrounding geography and land use.

The impact from railway operations depends on a range of factors including train type and speed, operational practices, wheel maintenance, line maintenance, the extent of shielding or noise barriers, the location of certain rail infrastructure such as cross overs and steel bridges and proximity and design of adjoining development. Other areas of rail operations, such as train stabling locations, maintenance yards and depots also have the potential to result in noise and vibration impacts.

The level of traffic noise from a road is directly related to the volume, type and speed of traffic, distance (unobstructed) from a road and the type of ground cover or road surface. The influence of ground cover on noise level increases with distance from the road. Traffic noise should not exceed the noise levels recommended in the ECRTN.

At a traffic volume of 40,000 Annual Average Daily Traffic (AADT) and a speed of 70 kilometres per hour, noise levels in excess of the noise level targets in the ECRTN occur at distances out to around 100 metres from a roadway where there are no intervening structures and where the ground cover is lawn, gardens, pastures, bushland or similar. Under this Guideline only those new residential and noise sensitive building developments with a clear line-of-sight to the road traffic need to be assessed for noise mitigation measures.

3.4 WHAT NOISE AND VIBRATION CONCEPTS ARE RELEVANT?

The following definitions aim to assist the understanding of key technical terms relating to noise and vibration.

Airborne noise

Most noise is termed airborne noise, indicating that it propagates between the source and receiver primarily through the air.

Noise or sound consists of minute fluctuations in atmospheric pressure capable of detection by human hearing. Noise levels are expressed in terms of decibels, abbreviated dB or dB(A), the A indicating that the noise levels have been weighted to approximate the characteristics of normal human hearing. Because noise is measured using a logarithmic scale, 'normal' arithmetic does not apply, eg. adding two sources of sound of an equal value results in an increase of 3dB (ie. 60dB(A) plus 60dB(A) results in 63dB(A)). A change of 1 dB or 2 dB in the level of a sound is difficult for most people to detect, whilst a 3dB–5dB change corresponds to a small but noticeable change in loudness. A 10dB change roughly corresponds to a doubling or halving in loudness.

Ground-borne noise

Ground-borne noise propagates through the ground as vibration and is then radiated as noise by vibrating wall and floor surfaces. The ISO Standard 14837 *Mechanical vibration – Ground-borne noise and vibration arising from rail systems* defines ground borne noise as noise generated inside a building by ground-borne vibration generated from the pass-by of rolling stock on rail.

This noise has a rumbling character, which has been likened to the sound of distant rolling thunder. It is normally noticeable only in areas that are well protected from airborne noise, such as buildings adjacent to railway tunnels. Ground-borne noise is also often referred to as 'regenerated' noise.

Background noise levels and other ambient noise are important factors in determining whether ground-borne noise will affect amenity. A high background noise generally masks other noises.

Noise measurements are usually averaged over a period.

- Leq is termed the equivalent continuous level as the averaging process involves smoothing out fluctuations in the level of noise.
- LAeq(15h) refers to the LAeq evaluated over a fifteen-hour period between 7am and 10pm.
- LAeq (9h) refers to the LAeq evaluated over a nine-hour period between 10pm and 7am
- In the case of the LAeq (1h) descriptor, the highest 10th-percentile hourly A-weighted Leq noise level applies when the particular class of building/place is in use.
- LAm_{ax} – refers to the maximum noise level occurring during a measurement period.

For an Leq based on averaging a number of noise events (such as rail passbys) an increase of 2dB is equivalent to:

- increasing the number of passbys by 60 percent, or
- reducing the distance between the railway and receptor by 40 percent (eg: from 25 metres to 15 metres (in a straight line)).

Vibration

Vibration can be measured in terms of its acceleration, displacement or velocity. Most assessments of human response to vibration are carried out in terms of averaged root mean square (rms) acceleration. Most assessments of the risk of damage to buildings use measurements of peak velocity. The common units for acceleration are metres per second per second (m/s²). As with noise, decibel units can also be used, in which case the reference level should always be stated.

3.5 WHEN IS AN ACOUSTIC ASSESSMENT NEEDED?

Acoustic assessments for noise sensitive developments (as defined in clauses 87 and 102 of the Infrastructure SEPP) may be required if located in the vicinity of a rail corridor or busy roads. If proponents and/or consent authorities are unsure about the likely impact, it is best to obtain preliminary acoustic advice to determine whether the development can comply with the appropriate noise and vibration criteria without special acoustic treatments.

Noise generated by road and rail sources has different characteristics and therefore must be assessed against different criteria. Road traffic noise from roads carrying more than 40 000 vehicles per day generates a continuous noise level. Rail noise sources are more intermittent but may have higher sound pressure levels.

The following provides an overall summary of the assessment procedure to meet the requirements of clauses 87 and 102 of the Infrastructure SEPP. The procedure covers noise at developments for both Road and Rail.

Some commercial premises may incorporate special components that may be noise and or vibration sensitive, such as auditoria, laboratories and board rooms, and although not a specific requirement of the Infrastructure SEPP, these areas should be assessed accordingly. While low rise buildings may benefit from shielding provided by topography, barriers or other buildings, high rise buildings usually receive less shielding and noise mitigation needs to be considered at the outset in the layout and building design.

For Clauses 87 (Rail) and 102 (Road):

- If the development is for the purpose of a building for residential use, the consent authority must be satisfied that appropriate measures will be taken to ensure that the following LA_{eq} levels are not exceeded:
 - in any bedroom in the building : 35dB(A) at any time 10pm–7am
 - anywhere else in the building (other than a garage, kitchen, bathroom or hallway): 40dB(A) at any time.

ACOUSTIC ASSESSMENT PROCEDURE

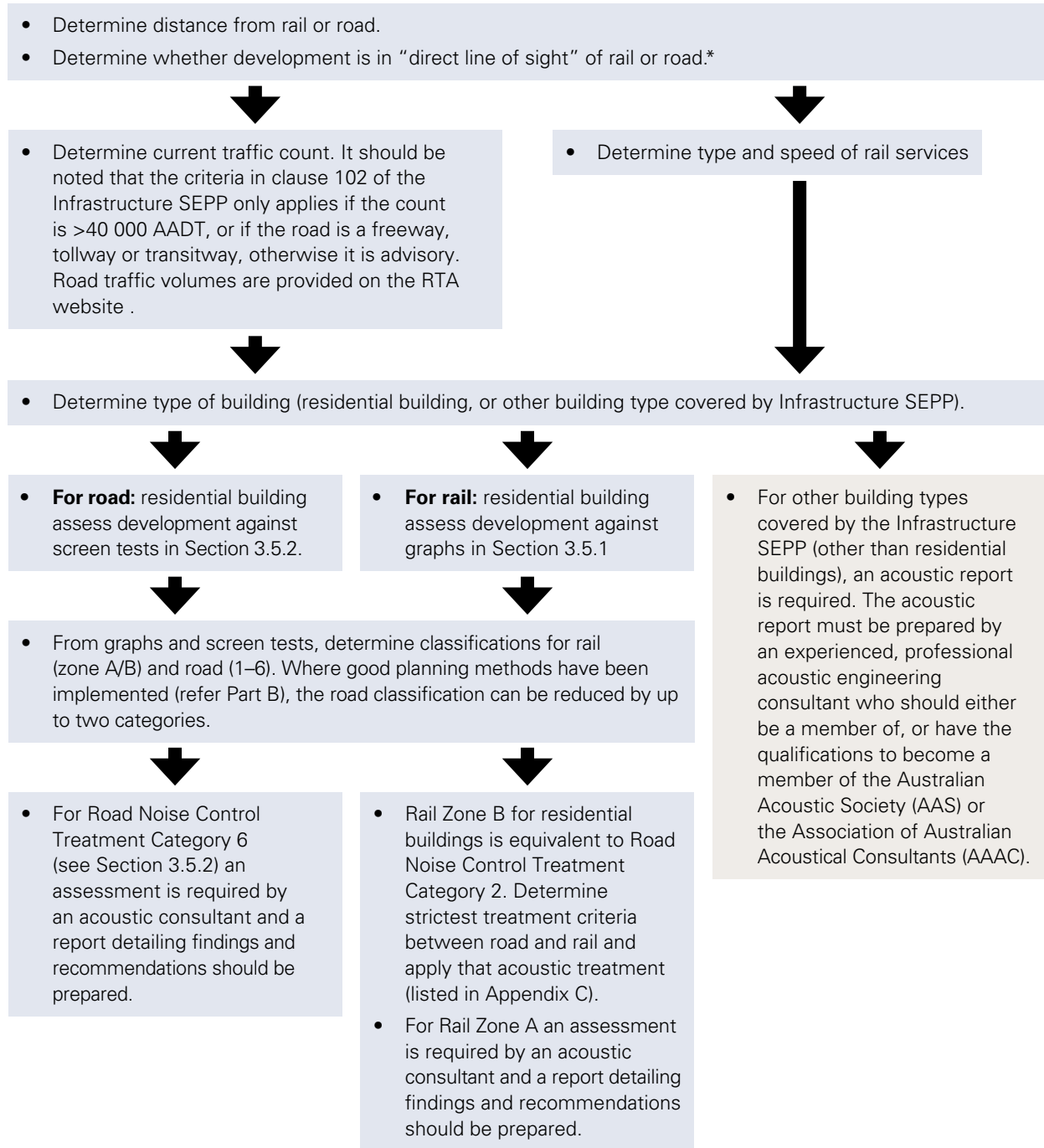

*Direct line-of-sight

- Only solid objects that break the line-of-sight have an ability to reduce noise. To be effective in reducing the level of noise views to the road must be totally blocked by solid objects such as buildings, hills or topography.
- Line-of-sight of a development to the road should be an important consideration in using **Figures 3.3** and **3.4** (see pages 17–19).

3.5.1 RAIL CORRIDORS

Noise

Figure 3.1 provides a guide as to the level of assessment required when noise sensitive developments are located in the vicinity of existing rail lines. Zones A and B are indicative acoustic assessment zones where sensitive land-uses are likely to be adversely affected. Where there are noise maps available based on actual rail movements the noise map information should be used in preference to **Figure 3.1**.

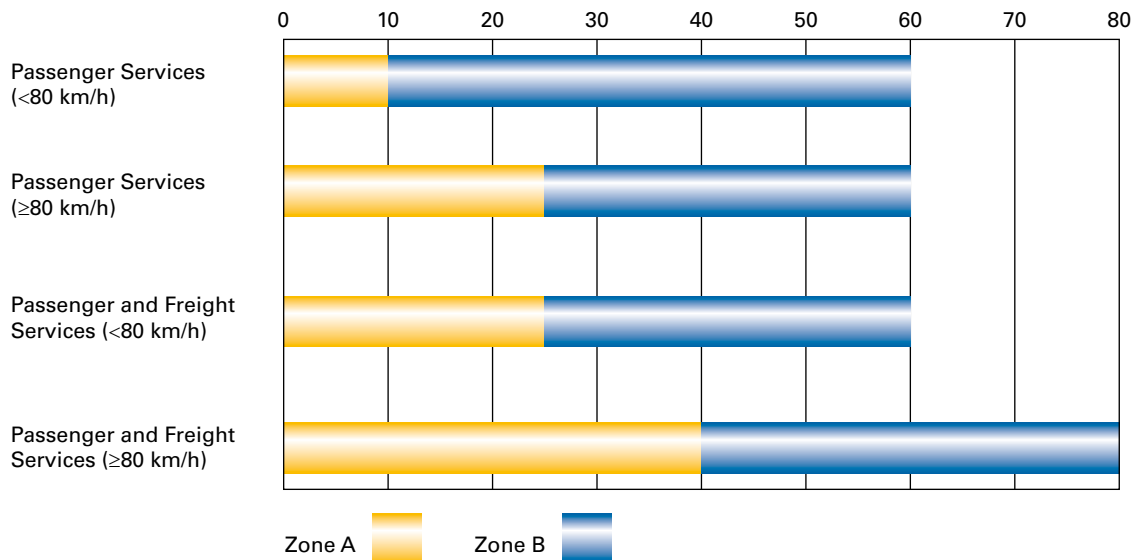

Figure 3.1: Acoustic Assessment Zones based on distance (m) of noise-sensitive development from operational track (not corridor)

Within Zone A, a full noise assessment should be undertaken.

For single dwelling residences in Zone B, the standard mitigation measures consistent with Road Noise Control Treatment Category 2 (refer road section below and Appendix C), for development will normally provide adequate mitigation to reduce internal noise levels to an acceptable level. If these measures are adopted as a minimum for single dwelling residences in Zone B, there should be no need for a specialist acoustic assessment. However the particular circumstances would also need to be considered.

It should be noted that the Zone B standard mitigation measures are based on having windows and external doors closed, therefore consideration of ventilation requirements for noise-exposed rooms will be required to meet the provisions of the Building Code of Australia and other relevant standards. To minimise sleep disturbance, air should be ducted into these rooms from a quiet area not exposed to rail noise or through the use of quiet, acoustically treated ventilators.

If the applicant considers that the above treatment is not warranted, then advice should be sought from an acoustic consultant to justify an alternative approach.

Particular considerations for Zone B:

- In locations where noise levels are higher especially next to train stabling yards, freight lines and high speed operations, it may be advisable to seek specialist acoustic advice from an acoustic consultant to confirm that the measures will achieve the desired noise criteria.
- In locations where trains are obscured from view by impervious objects such as the ground, noise barriers or other buildings, the acoustic treatment may not be needed. Trees or non-lapped paling fences are not good noise barriers and noise mitigation is still advisable in these circumstances.

Rail Vibration

The vibration assessment zone for typical development sites adjacent to rail corridors or above rail tunnels is shown in **Figure 3.2**. The assessment zone may need to be increased for specific areas where vibration issues are known to already exist. Refer to section 3.6.3 vibration criteria for additional information. Developments within this zone will need a vibration assessment.

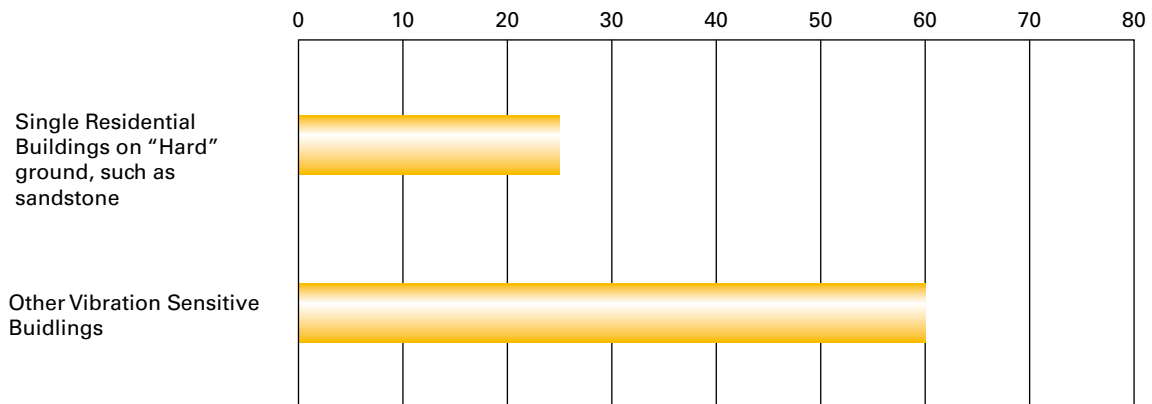

Figure 3.2: Distance from the nearest operational track (m)

3.5.2 BUSY ROADS

The acoustic assessment required is different for single/dual occupancy dwellings, multiple dwelling and other sensitive developments. A more detailed level of acoustic design is needed for multiple dwelling developments because there is generally greater complexity of building design and lay-out. This complexity contributes to a greater risk of unacceptable noise with more people likely to be affected. Significant cost-savings in construction and material costs are possible if residential flat buildings are designed with traffic noise in mind from the concept design stage.

Screen tests have been developed for single dwelling developments and for residential flat buildings and other sensitive developments.

These screen tests apply **ONLY** to areas of a development (or facades of buildings) which are exposed to traffic noise and which have a direct line-of-sight.

The noise-affected facades can be on the noisy side of the building (with a direct exposure or line of sight) or on the flanks of a building (with an angled or indirect exposure to the road or rail line). The screen tests apply within a range of direct line-of-sight distances from 10 metres to 300 metres from the road kerb due to practical prediction limitations. Where a development is closer than 10 metres to the road it is likely to require special noise controls.

Single dwelling and dual occupancy

The screen test for single/dual occupancy dwellings in two traffic speed zones is shown in **Figures 3.3a** and **b**.

The screen tests take into account the volume of traffic and the distance between the proposed development and the road. If an acoustic assessment is necessary then the noise control treatment required can be selected from those recommended in Appendix C or alternate noise control treatments can be determined by a qualified acoustic engineer.

Standard noise control treatments are grouped into six categories. Category 1 areas are those likely to have low road traffic noise and Category 6 areas are likely to have the highest road traffic noise. Each category refers to a set of standard construction methods and building materials for each key element of a building with the aim of achieving the internal performance criteria for noise identified in clause 102(3) of the Infrastructure SEPP. Details on each category are provided in Appendix C. While the noise treatments identified will reduce internal noise, they are not guaranteed in every case to achieve compliance. The proponent/consent authority may therefore choose to consult an acoustic engineer to undertake a more detailed site-specific assessment in order to more accurately determine noise impacts.

Screen Test 1(a) – Habitable Areas 60/70 km/h

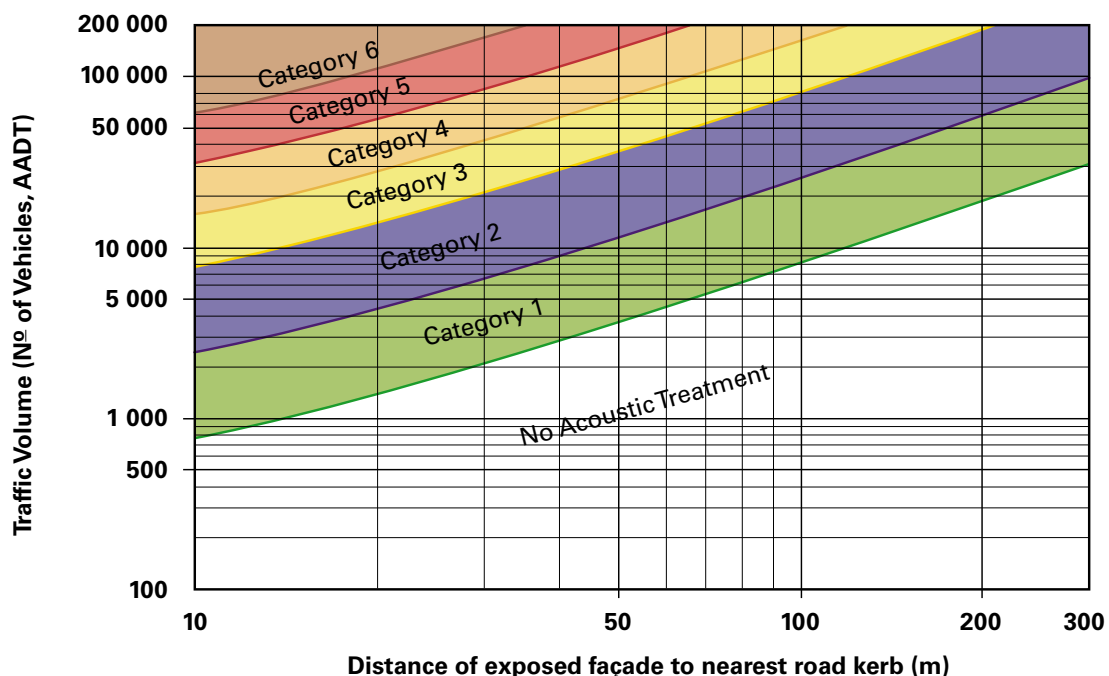

Figure 3.3(a): Screen tests for habitable areas of single/dual occupancy dwellings (if any exposed façade is direct line-of-sight)

Screen Test 1(b) – Habitable Areas 100/110 km/h

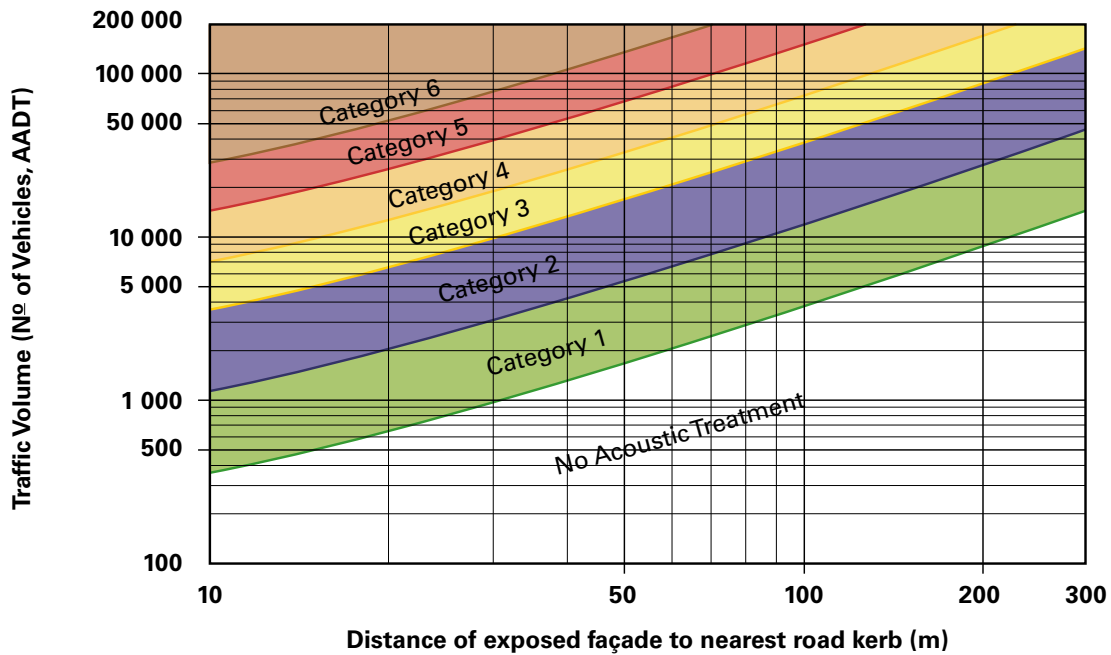

Figure 3.3(b): Screen tests for habitable areas of single/dual occupancy dwellings (if any exposed façade is direct line-of-sight)

Residential flat buildings and other sensitive developments

The screen tests (Figures 3.4a and b) for residential flat buildings and other sensitive developments take into account the volume of traffic and the distance between the proposed development and road. The screen test should be conducted to establish whether or not an acoustic assessment is required. If an acoustic assessment is necessary then the noise control treatment required should be determined by a qualified acoustic engineer.

Screen Test 2(a) – Habitable Areas 60/70 km/h

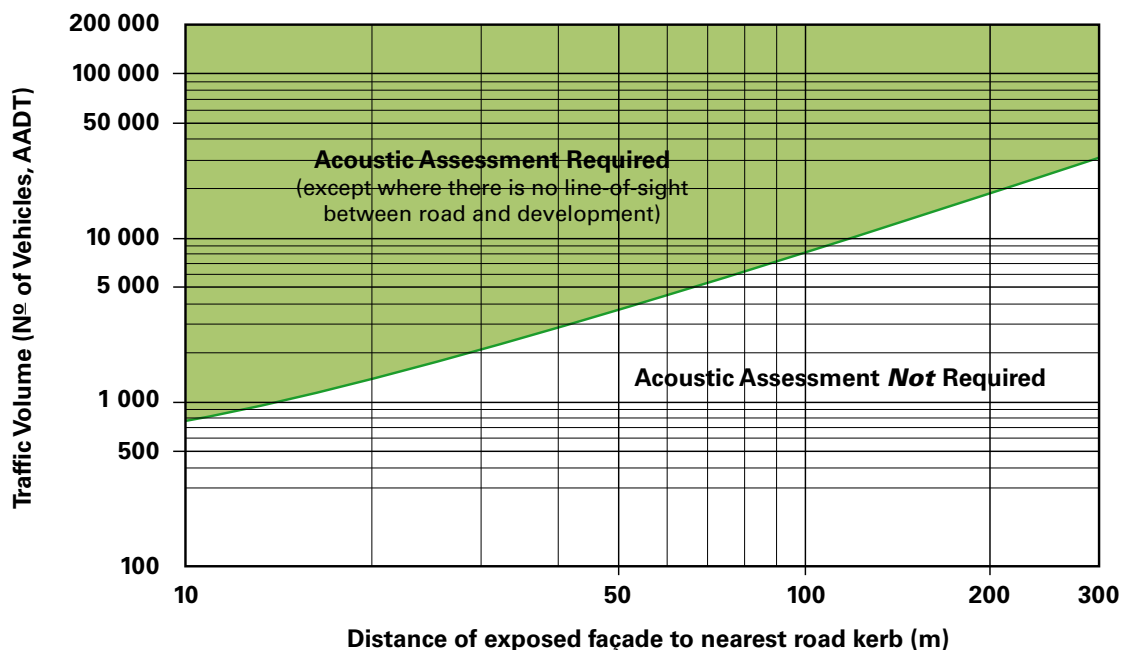

Figure 3.4(a): Screen tests for habitable areas of multiple dwellings (noting that any exposed façade is direct line-of-sight)

Screen Test 2(b) – Habitable Areas 100/110 km/h

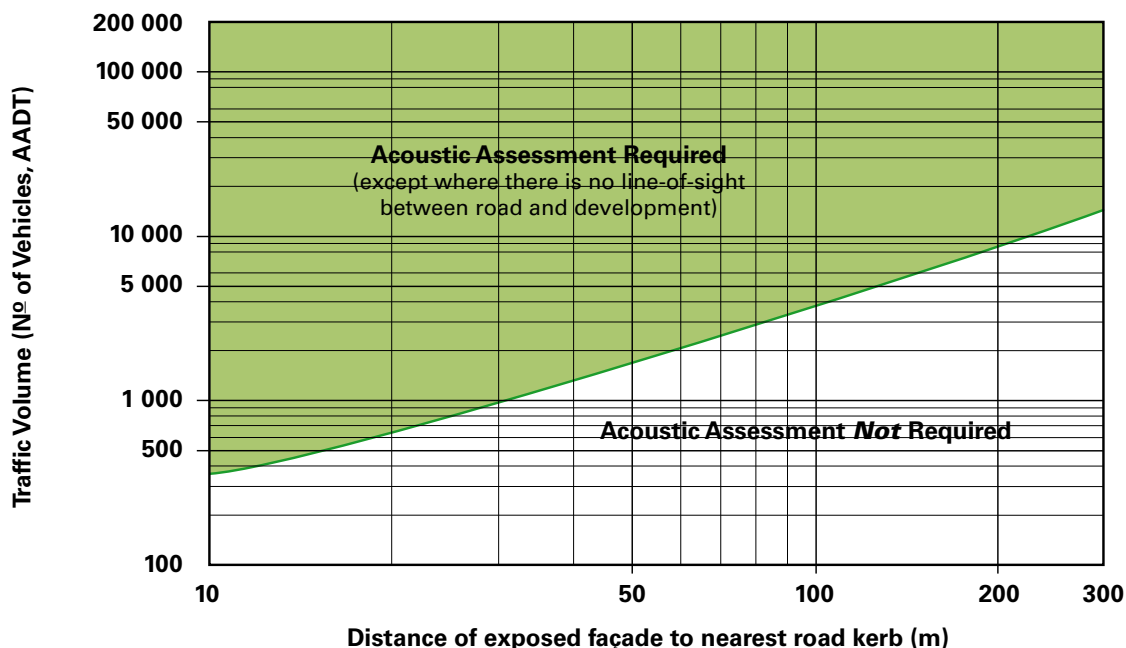

Figure 3.4(b): Screen tests for habitable areas of multiple dwellings (noting that any exposed façade is direct line-of-sight)

3.6 WHAT NOISE AND VIBRATION CRITERIA SHOULD BE APPLIED

3.6.1 Airborne Noise

The noise criteria for residential buildings in **Table 3.1** for both road and rail are specified in the Infrastructure SEPP. Other values in **Table 3.1** are based on the Environmental Criteria for Road Traffic Noise (EPA 1999).

These criteria apply to all forms of residential buildings as well as aged care and nursing home facilities. For some residential buildings, the applicants may wish to apply more stringent design goals in response to market demand for a higher quality living environment.

The night-time 'sleeping areas' criterion is 5dBA more stringent than the 'living areas' criteria to promote passive acoustic design principles. For example, designing the building such that sleeping areas are less exposed to road or rail noise than living areas may result in less onerous requirements for glazing, wall construction and acoustic seals. If internal noise levels with windows or doors open exceed the criteria by more than 10dBA, the design of the ventilation for these rooms should be such that occupants can leave windows closed, if they so desire, and also to meet the ventilation requirements of the Building Code of Australia.

Table 3.1: Noise criteria

Residential Buildings		
Type of occupancy	Noise Level dBA	Applicable time period
Sleeping areas (bedroom)	35	Night 10 pm to 7 am
Other habitable rooms (excl. garages, kitchens, bathrooms & hallways)	40	At any time
Non-Residential Buildings		
Type of occupancy	Recommended Max Level dBA	
Educational Institutions including child care centres	40	
Places of Worship	40	
Hospitals	- Wards	35
	- Other noise sensitive areas	45

Note: airborne noise is calculated as $L_{eq}(9h)$ (night) and $L_{eq}(15h)$ (day). Groundborne noise is calculated as L_{max} (slow) for 95% of rail pass-by events.

3.6.2 Ground borne noise

Generally, ground borne noise is associated more closely with rail operations than roads. Where buildings are constructed over or adjacent to land over tunnels, ground-borne noise may be present without the normal masking effect of airborne noise. In such cases, residential buildings should be designed so that the 95th percentile of train pass-bys complies with a ground-borne L_{Amax} noise limit of 40dBA (daytime) or 35dBA (night-time) measured using the "slow" response time setting on a sound level meter.

The Interim Guidelines for the Assessment of Noise from Rail Infrastructure Projects (DECC 2007) provides further guidance on this issue.

In some rare instances, ground borne noise may be an issue for noise sensitive locations adjacent to surface or elevated track (ie. not just track in tunnel locations). These instances are uncommon, are not easily predicted, and will need to be assessed and managed on an individual basis, with the assistance of an acoustic consultant.

As a general guide, groundborne noise may be an issue in habitable rooms which are shielded from airborne noise from the railway. Examples are rooms that are not facing the railway, and where cuttings or noise barriers block the line of sight between the receiver room and the rail line. In addition, some structures such as suspended slabs can lend to vibration amplification.

3.6.3 Vibration criteria

Vibration levels such as the intermittent vibration emitted by trains should comply with the criteria in *Assessing Vibration: a technical guideline* (DECC 2006). The standards used for assessing the risk of vibration damage to structures are German Standard DIN 4150 Part 3 1999 and British Standard BS 7385 Part 2 1993. Human comfort is normally assessed with reference to the above British Standard or Australian Standard AS 2670.2 1990.

3.7 WHAT A NOISE ASSESSMENT REPORT SHOULD CONTAIN

3.7.1 Seeking early advice

It is best to consider noise and vibration issues in the early stages of planning for the development. Each location may be different.

Some of the factors affecting the level of noise and vibration impacts from rail corridors and busy roads Include:

- topography, distance from the road/track,
- shielding by other structures
- track/road configuration and condition

- the maintenance regime on the road/line
- pavement type of road
- road grades
- truck or train numbers
- characteristics of the rolling stock using the rail line and presence of stabling yards
- daily changes in rail/traffic operations

Given the site-specific nature of noise and vibration, an acoustic consultant can be of assistance in providing advice on the optimum layout and design to minimise noise and vibration impacts and provide an acoustic amenity that is appropriate for the use.

Acoustic consultant:

If required an acoustic assessment should be carried out by a noise and vibration consultant with suitable technical qualifications and experience, consistent with the technical eligibility criteria required for membership of the Australian Association of Acoustical Consultants (AAAC) and/or the grade of membership of the Australian Acoustical Society denoted MAAS.

Particular considerations:

Guidance on internal noise levels for roads may be obtained from the following standards:

- AS 2107:2000 Acoustics - recommended design sound levels and reverberation times for building interiors
- AS 2021:2000 Acoustics - aircraft noise intrusion - building siting and construction
- AS 3671:1989 Acoustics - road traffic noise intrusion - building siting and construction

3.7.2 The acoustic assessment

The acoustic assessment should document the level of noise and vibration impacts and describe the measures proposed to meet the noise and vibration criteria, and be included in the information accompanying the development application. Further details may also be required prior to issuing of a construction certificate.

Both internal and external spaces should be considered in the acoustic assessment, although the criteria provided in this document generally apply to internal spaces, which are regarded as the most sensitive. The consultant would need to carry out noise and/or vibration measurements and then calculate the resultant internal noise and vibration levels, taking into account the particular features and intended use of the proposed development. Detailed methodologies for acoustic assessment are provided in Appendix D.

3.8 AVOIDING ADVERSE AIRBORNE NOISE AND VIBRATION IMPACTS BY GOOD DESIGN

Good design requires careful consideration of a whole range of factors – noise and vibration are just some of these. The location and orientation of buildings and the internal layout – all of which affect the exposure of sensitive spaces to traffic or railway noise. Both internal and external spaces should be considered in the acoustic design.

The layout and configuration of a development should also respond to the local environment. In the case of development near a rail/busy road corridor, this includes the location of road/rail infrastructure, existing noise levels, topography and nearby buildings. The potential benefit of noise barriers and acoustic shielding from other structures should be considered along with the use of appropriate windows, doors, ventilation and facade materials. Planning the development from site location, through concept design and materials selection can greatly minimise acoustic impacts. It can substantially reduce the requirement and costs of attenuation measures that may need to be applied to the development.

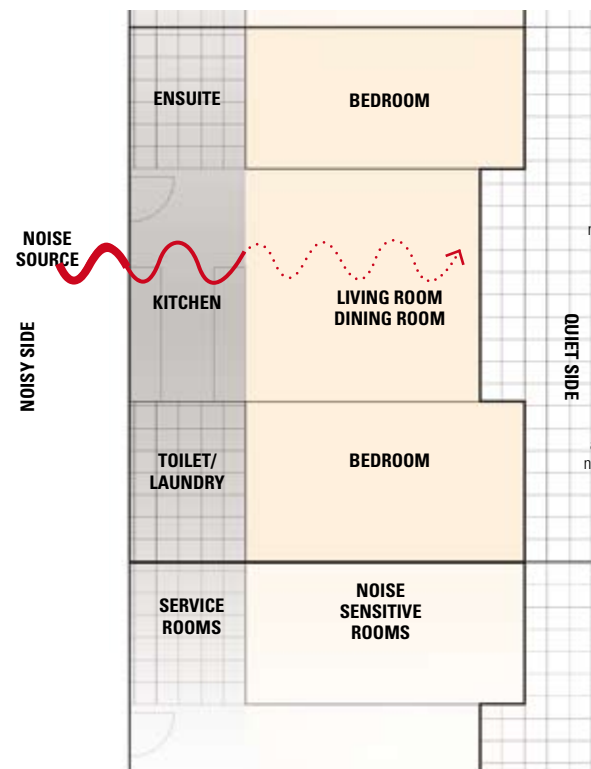

Figure 3.5: Single Dwellings – locating noise sensitive rooms away from road noise

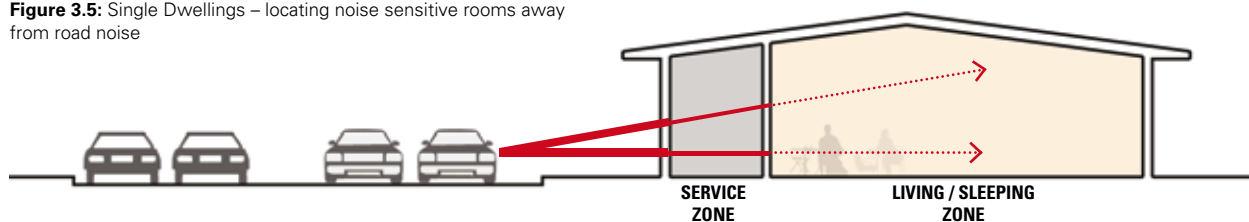

Figure 3.6: Multiple dwellings – locating noise sensitive rooms away from road noise

3.8.1 Subdivisions and new land release

When considering major renewal of areas, business parks or the subdivision of land located near busy roads or rail corridors, potential noise and vibration impacts should be considered at the master planning/concept planning stage. At this stage there is more opportunity to address noise and vibration through setbacks, building orientation, layout, building height controls or noise barriers. In some cases, it might be appropriate to design open spaces adjacent to the busy road/railway corridor to setback residential uses to reduce noise exposure. These open space areas could also include appropriate bunding to buffer adverse noise impacts and provide for cycle or pedestrian paths along the road/railway line to improve accessibility.

3.8.2 Building location, design orientation and room layout

While low rise buildings may benefit from shielding provided by topography, barriers or other buildings, high rise buildings usually receive less noise shielding and noise mitigation needs to be considered at the outset in the layout and design stage.

A key element of good acoustic planning and design involves increasing the separation between the road/rail noise sources and the noise sensitive area. As an indication, doubling the distance from the noise source to the receiver will normally reduce the noise levels by between 3dBA and 6dBA.

Sleeping areas and other habitable areas should be placed on the side of the building furthest from the source of noise (road or rail line). Conversely rooms which are less sensitive (laundries, bathrooms, storage rooms, corridors, stairwells, etc.) should be placed on the noisy side of the building to act as a noise buffer. An additional way of minimising the intrusion of noise is to minimise the number of doors and windows (particularly windows that can be opened) on the noisy side of the dwelling.

Figures 3.5 and 3.6 provide examples of building layouts which place less sensitive service areas on noise affected facades. These arrangements provide effective shielding and distance to the more sensitive sleeping areas and other habitable areas.

More examples of noise sensitive layouts are illustrated in Figures 3.7 and 3.8. A series of solid walls and a room configuration that uses the garage to shield the house from noise and that locates bedrooms furthest from the noise source are important design elements to reduce adverse noise (see also Appendix B).

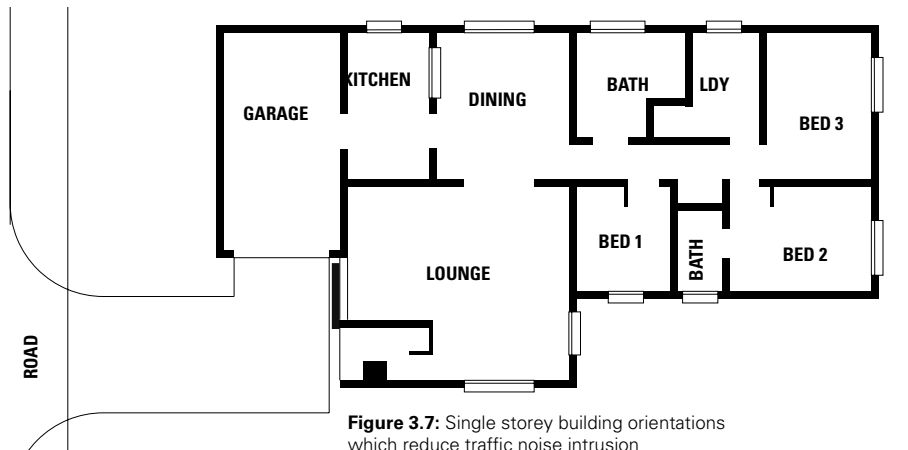

Figure 3.7: Single storey building orientations which reduce traffic noise intrusion

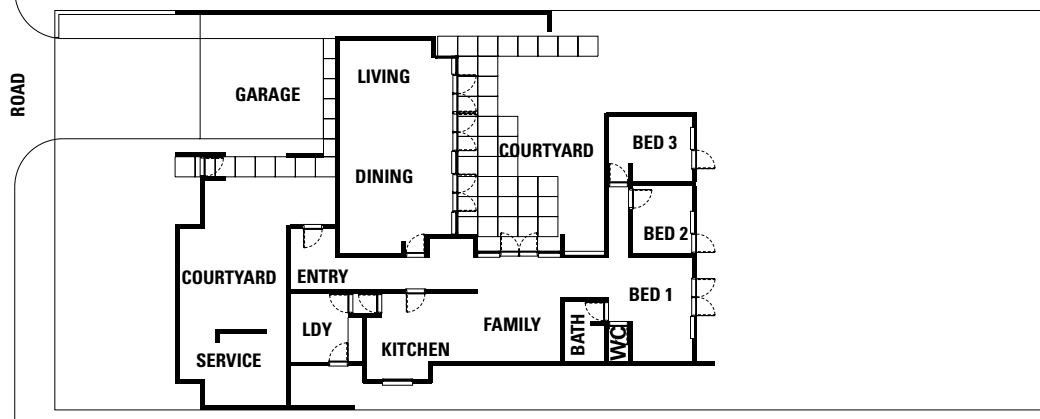
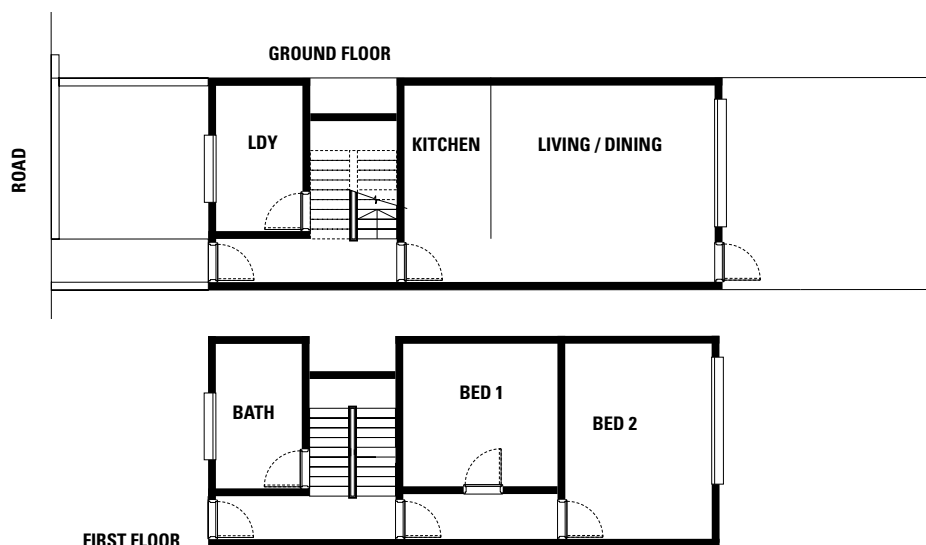

Figure 3.8: Double storey building orientation which reduces traffic noise intrusion



3.8.3 Buildings as noise shields

On larger developments, a barrier block (see **Figure 3.9**) can be used to protect the residential development from noisy roadways. A barrier block is a building which itself forms a noise barrier.

Main considerations when designing a 'barrier block':

- The block should run along the edge of the site parallel to the noise source and wrap around the sides of the property to protect the sides
- Noise sensitive rooms in the barrier block should face away from the noise source
- Rooms on the 'noisy' side of the block may need heavy insulation and mechanical ventilation
- Consider measures to ensure passive surveillance to avoid potential for graffiti or other anti-social activity

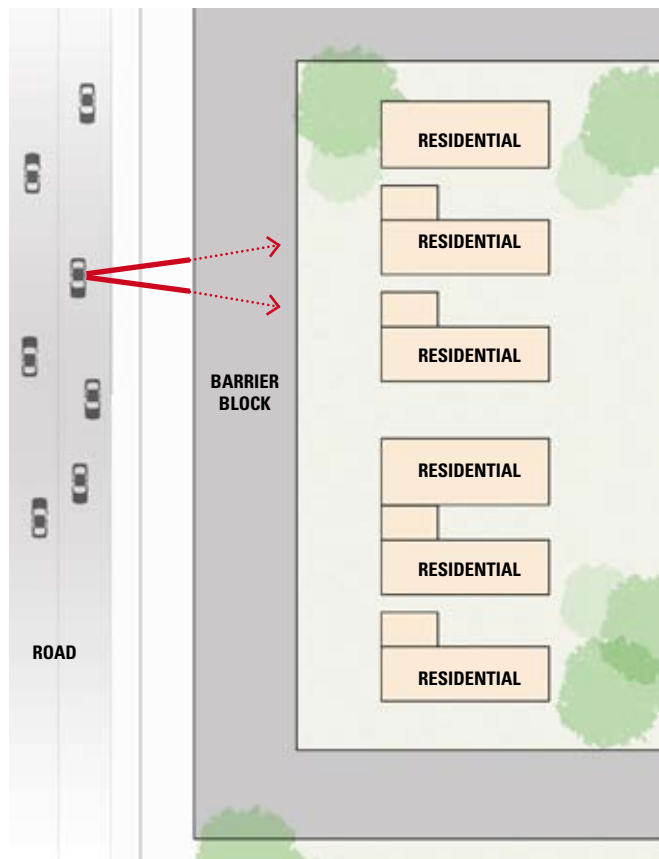

Figure 3.9: Barrier Block

A continuous frontage see **Figure 3.10** (using a solid wall to extend to the boundary if necessary) is one way to lower noise levels in the rest of the property. Site planning and internal layout of buildings should also be considered. This is likely to be more easily achieved where properties are being developed concurrently.

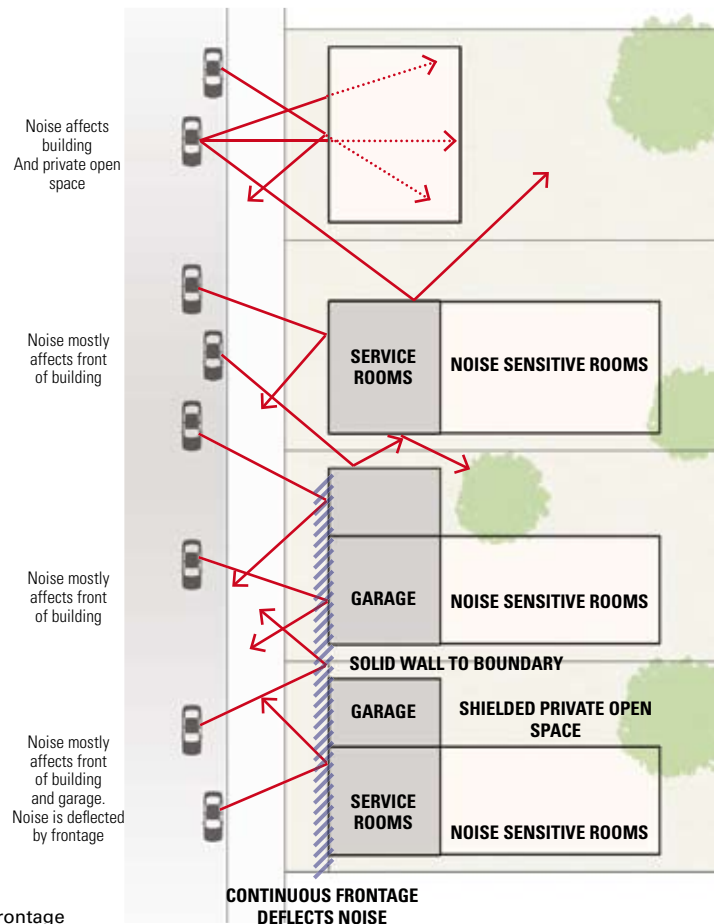
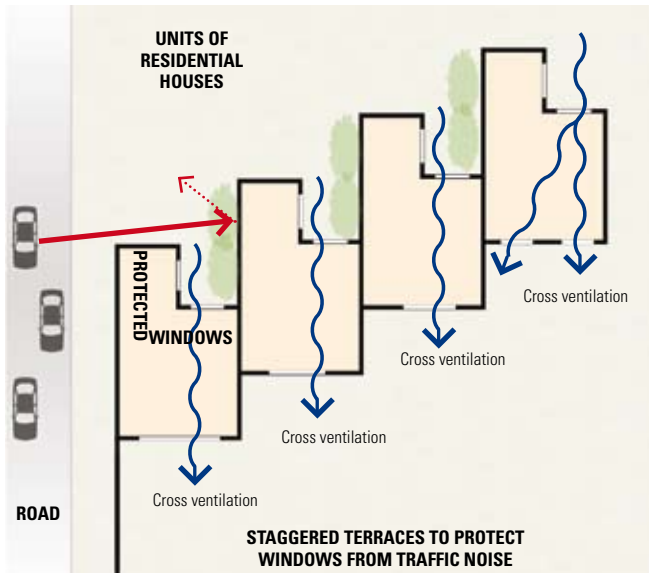
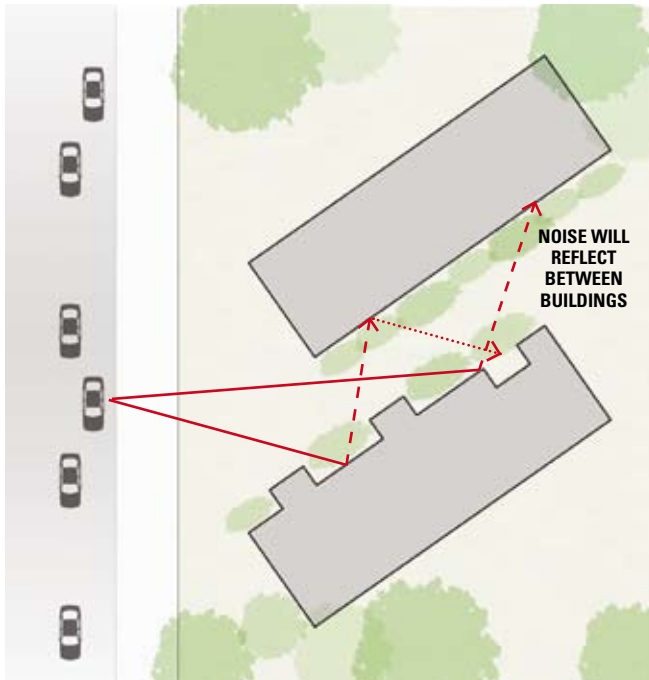

Figure 3.10: Continuous frontage



Staggered terrace houses, for example, can be arranged to shield most windows from traffic noise whilst allowing them to be opened for natural ventilation (**Figure 3.11**).

Figure 3.11: Staggered terraces to protect windows from traffic noise



Angled buildings can reflect sound back into other buildings (**Figure 3.12**). Articulated facades and vegetation may help to diffuse the reflected noise (but do little to inhibit noise directly from the source). This design should therefore be avoided.

Figure 3.12: Angled buildings may reflect traffic noise and should be avoided

3.8.4 Podiums, balconies and courtyards

Podiums

Traffic noise can be substantially reduced by building residential apartments on top of a podium or commercial building space. If the residential tower is set back the podium acts to provide increased distance from the road thus shielding noise from the road to the lower apartments (see **Figures 3.13** and **3.14**).



Figure 3.14: Example of commercial podium with residential apartments above

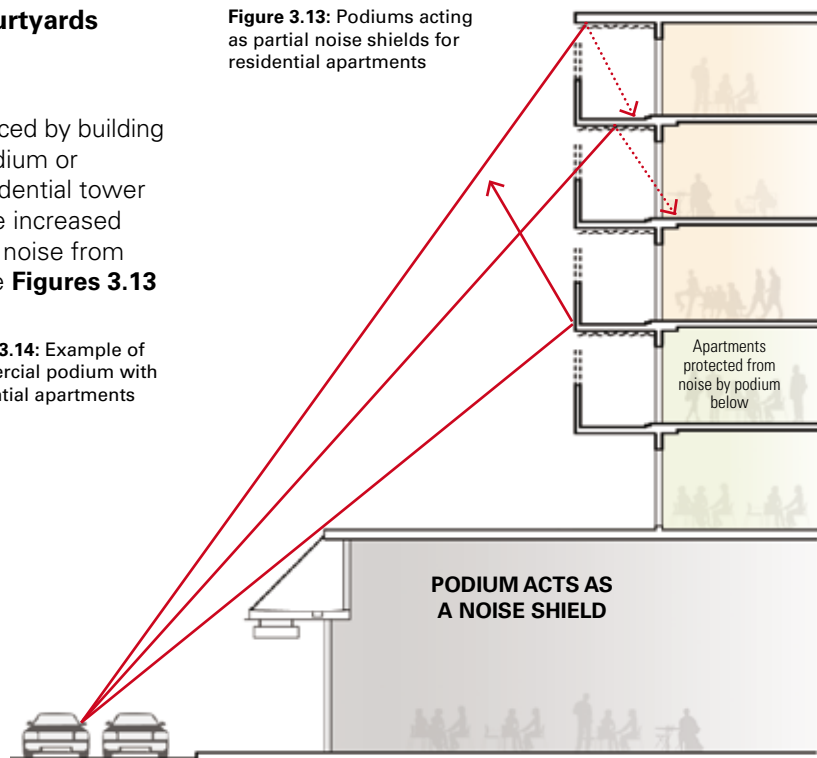

Figure 3.13: Podiums acting as partial noise shields for residential apartments

Balconies

When considering balconies in building design it is important to note that the standard jutting balcony may act to reflect noise directly into the interior of the building as illustrated in the **Figure 3.15**.

Where balconies are required, solid balustrades with sound absorption material added to the underside of balconies above is a good means of reducing noise entering the building.

Providing enclosed balconies (or winter gardens) is another means of reducing the noise entering a building. Where enclosed balconies are used ventilation may need to be considered. By installing acoustic louvres ventilation requirements and reduced noise can be addressed. These approaches are shown in **Figure 3.16**.

Figure 3.15: Balcony treatments which reduce traffic noise intrusion

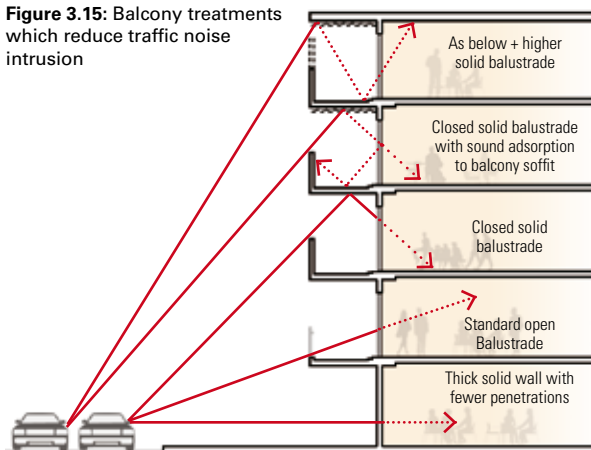

It should be noted that although balconies should be located away from a road, where this occurs on the southern side of a development it may result in space that is not used and that is of low amenity.

Figure 3.16: Enclosable balconies facing the road

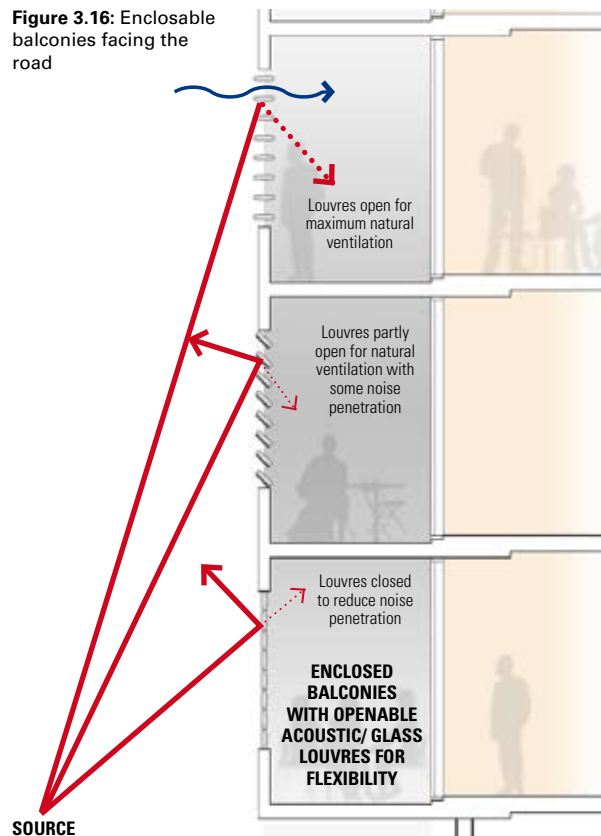

Courtyards

There are several ways noise can be reduced in external recreational areas. One way is to increase the distance between the road and the external recreational area. Another is to provide a screen or noise barrier. Incorporating shielded courtyards into the design can also protect occupants from traffic noise.

Use of good building layout is another way of reducing noise to external courtyard areas as illustrated in **Figure 3.17**. Buildings in 'C' shaped layouts can also be utilised to create outdoor areas protected from noise.

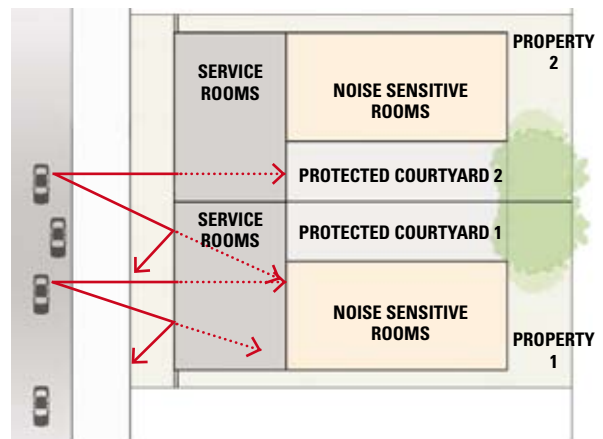

Figure 3.17: Noise shielded courtyards

3.8.5 Noise Barriers, Mounds and Screens

A noise barrier is an effective way to reduce traffic noise.

Where space allows, raised mounds of earth can be effective noise barriers and can be enhanced by placing a low wall on top. Fencing built on top of mounds can save the space a larger mound might take and reduce the amount of fencing material required. All of these options are depicted in **Figures 3.18a**, **3.18b** and **3.19**.

Noise barriers may include:

- An existing feature, such as a natural slope or an elevated road
- A purpose designed feature such as a solid boundary fence
- A purpose designed feature of the building, such as a partially enclosed carport
- A purpose designed building which acts as a barrier block (see **Figure 3.9** above)

Figure 3.18a: Noise barrier using an earth mound

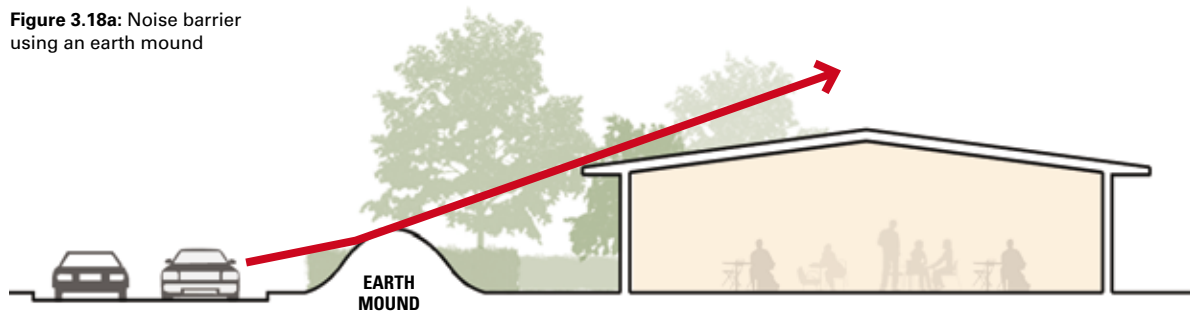

Figure 3.18b: Noise barrier using an earth fence/wall

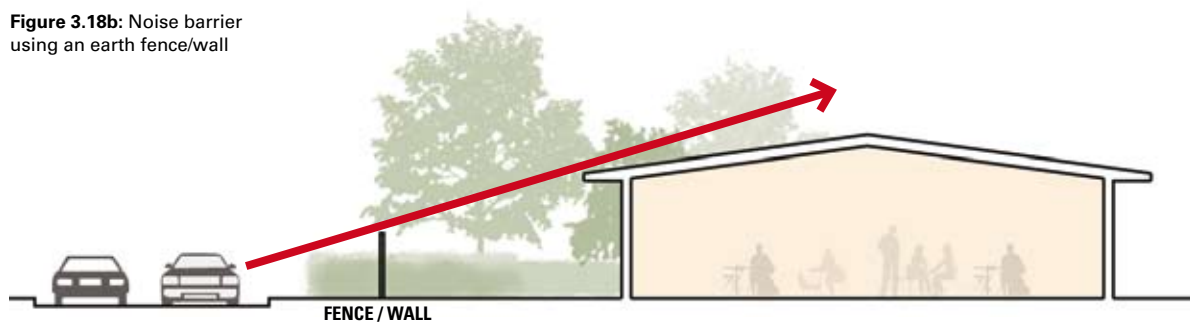
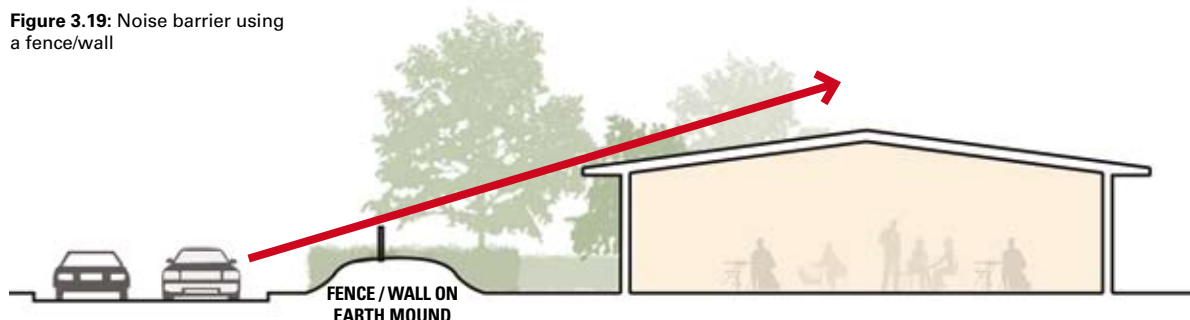

Figure 3.19: Noise barrier using a fence/wall



Topography plays a major role in determining adverse noise impact. A building which is sited below the level of the noise source will be impacted less than a building which is sited above the noise source, especially if a noise barrier (like a mound or wall) is provided at the top of the slope (see **Figure 3.20**).

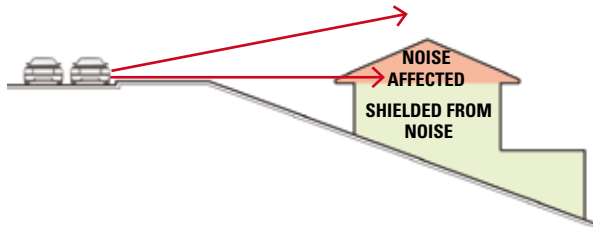

Figure 3.20: Topography and noise barriers

Careful consideration of site design can mitigate the effects of a site above the noise source by, for example, positioning a garage in the noise affected areas and using noise walls to buffer noise.

Solid walls and fencing with no openings can reduce noise. Where a gate is required ensure it is of solid construction, it is of the same height as the wall, it overlaps the wall and it has rebated meeting edges as shown in **Figure 3.21**. Measures to avoid graffiti should be considered when designing noise barriers (see Section 5.7)

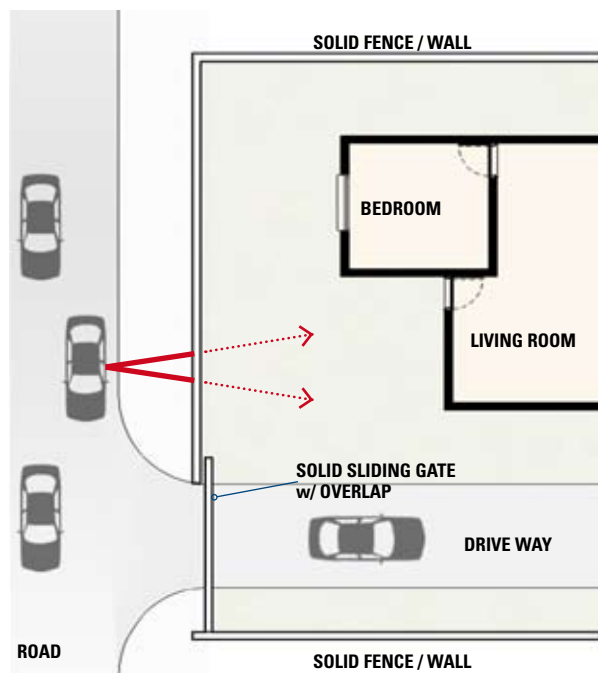
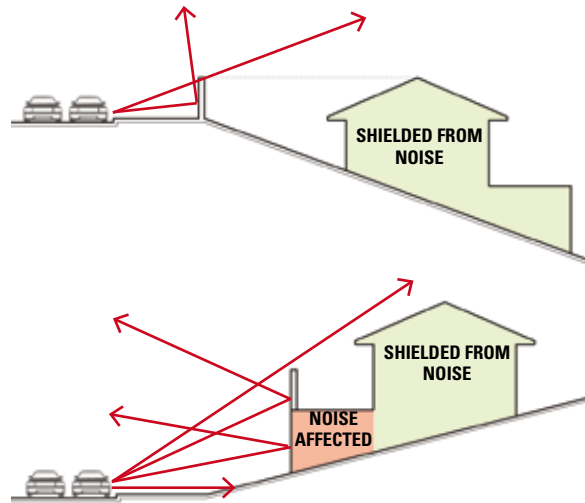

Figure 3.21: Solid fences and solid gates for access

Figure 3.22 shows another vehicle access arrangement which minimises noise by using one wall that overlaps another.

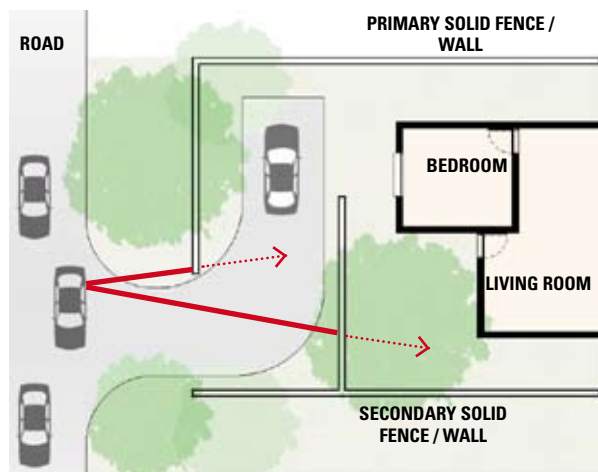

Figure 3.22: Overlapping solid fences for access



Figure 3.23: Examples of noise barriers and screens protecting developments from road noise

Where noise screens cannot be built to cover the whole facade of a building facing the road, it is often possible to consider shorter local screens to shield noise affecting the openings to the building (ie for windows and doors) as shown in **Figure 3.24**. This allows natural ventilation with a substantial noise reduction.

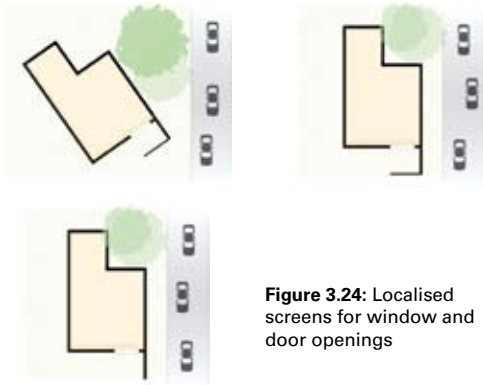
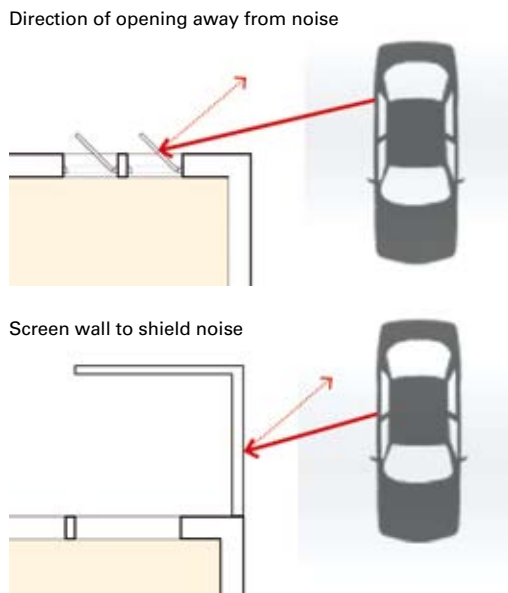

Figure 3.24: Localised screens for window and door openings



Direction of opening away from noise

Screen wall to shield noise

Solid fencing is one effective method of reducing noise. **Figure 3.25** illustrates various types of solid fencing: a masonry wall, a lapped-timber fence (without gaps) and a double-layer of common steel fencing that all can be effective in reducing traffic noise. Noise barriers are most effective at protecting outdoor areas and ground floor levels of buildings. Single-storey dwellings are therefore easier to shield from noise than the upper floors of two-storey dwellings.

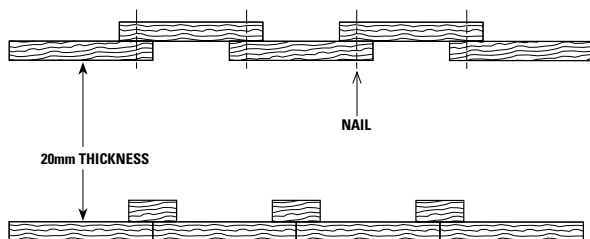

Figure 3.25a: Solid Timber Fencing

Main considerations when designing a noise barrier (all other things being equal):

- The closer the noise barrier is to the noise source, the more effective the barrier
- The lower the height of the development, the more effective the barrier
- The taller the barrier, the greater the noise reduction
- Barriers are more effective when the site slopes away from the source
- The wider the barrier, the more effective – barriers should ideally extend far beyond the edges of the development
- Any holes or discontinuities in a barrier wall will significantly reduce its noise reduction ability.
- Material used in the barrier must have a surface density of at least 20kg/m²

To be effective noise barriers, light-weight fences should:

- Be solidly built
- Planks or sheeting must be tight-fitting and without gaps
- To avoid gaps emerging as materials age or warp, the posts should be placed close together (less than every 2.5m) for rigidity and three horizontal support rails should be used
- Overlay horizontal or vertical planks by a minimum of 35 mm
- Use galvanised bolts and nails
- Use seasoned and treated timber to minimise shrinkage and increase the life of the timber
- Bury the bottom of the fence in the ground so there is no clearance gap beneath the fence.

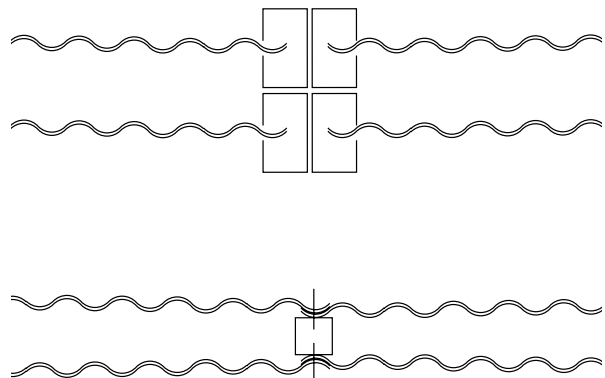

Figure 3.25b: Two Layers of Sheet Steel Fencing

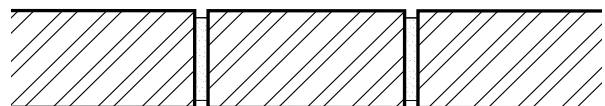

Figure 3.25c: Masonry Wall

3.8.6 Building treatments

Walls

Masonry walls typically have better noise insulation properties than other elements in the building envelope. Generally, walls are not a significant noise transmission path. Therefore attention should be given to the windows, doors, roof and ventilation openings as these elements will not insulate as well as the walls.

Walls of lightweight construction (eg weatherboard, compressed fibrous cement sheeting, timber slats, timber sheeting etc.) provide less noise insulation than masonry walls to low frequency noise. On noisy sites lightweight cladding should be avoided unless specifically designed to provide adequate insulation.

Whether the walls are masonry or of light-weight construction, the wall's insulation capacity will be weakened if it contains ventilators, doors or windows of a lesser insulation capacity. To improve insulation response, ventilators can be treated with sound-absorbing material or located on walls which are not directly exposed to the external noise.

Windows

In acoustic terms windows are one of the weakest parts of a facade. An open or acoustically weak window will severely negate the effect of an acoustically strong facade. Whenever windows are incorporated in a building design their effect on acoustic performance of the building facade should be considered. Reducing the numbers of windows and appropriately positioning them away from the road or rail line can be beneficial.

Proper sealing is crucial to the success of noise reduction of windows. To prevent sound leaks, windows should be caulked (with a flexible sealant such as mastic or silicone) thoroughly from the inside, and outside between the wall opening and the window frame. Ideally use one of the many commercially available double-glazed or laminated windows with acoustic seals (**Figure 3.26**). Laminated glass is usually cheaper and easier to install. Double-glazing can be achieved by installing two sets of single-glazed windows with a minimum separation gap of at least 50 millimetres between the two sets of windows.

The main factors influencing the acoustic performance of windows:

- Window seals: ensure windows are fitted with high quality acoustic seals and close windows to reduce internal noises levels.
- Reduce window size, recognising that reducing the proportion of window to wall size from 50% to 25% reduces noise by only 3 decibels.
- Increase the glass thickness: the thicker the glass the more noise resistance it provides. However, glass thickness is only practical up to a point before the costs exceed the acoustic benefits of increasing glass thickness.
- Double-glazing: is cost-effective when a very high level of noise attenuation is required. When using double-glazing, the wider the air space between the panes the higher the insulation
- The presence of absorbent materials on the window reveals will improve noise insulation.
- Window frames and their installation in wall openings must be air tight and openable windows must incorporate acoustic seals for optimal noise insulation

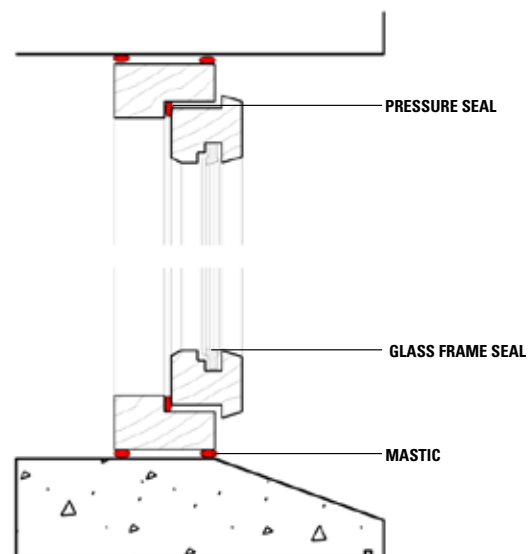

Figure 3.26: Window acoustic seals

The use of laminated and double-glazed windows and sliding glass doors provides added benefits as the building's thermal insulation properties are improved.

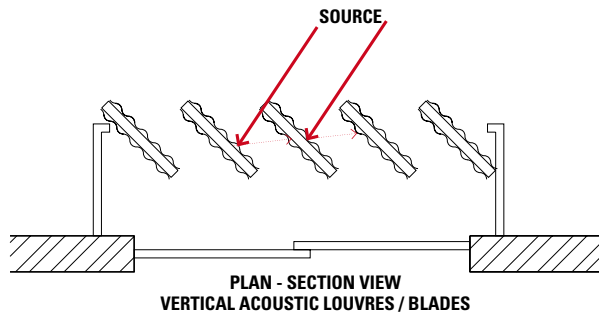
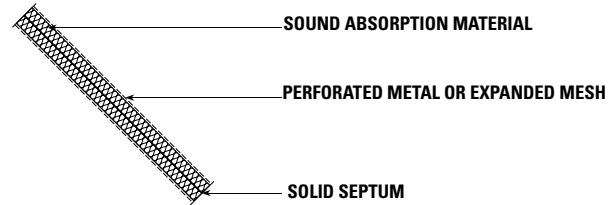

Figure 3.27: Acoustic louvres over window openings

The ventilation requirements of the building may sometimes conflict with thermal and noise insulation requirements. Where this occurs ventilation may need to be provided from the use of mechanical ventilation or acoustic vents. Vertical acoustic louvres/blades/fins can be used on outside windows in a range of sizes to provide a slight decrease to internal noise levels (Figure 3.27).



Externally mounted and sealed window roller shutters placed over window apertures can provide moderate levels of noise reduction and significant thermal benefits where the need for natural light or passive surveillance are not major issues (Figure 3.28).



Figure 3.28: Examples of roller shutters over window openings



Doors

The main factors influencing the acoustic performance of doors:

- Airtight seals should be used around the perimeter of the door.
- Cat flaps, letter box openings and other apertures should be avoided.
- The heavier (thicker or more dense) the door, the better the noise insulation.
- Ensure an airtight seal between the frame and the opening aperture in the facade.

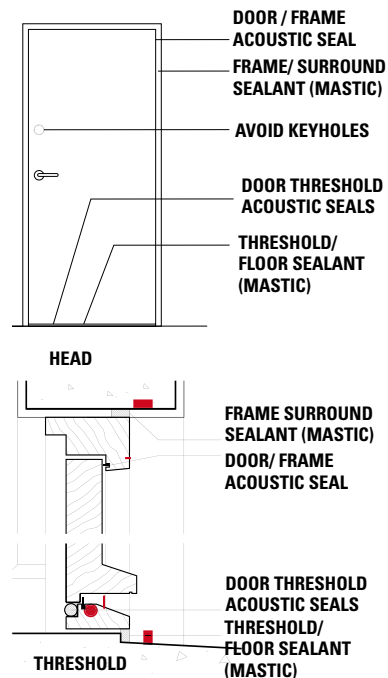

Figure 3.29: Door acoustic seals

Roofs

The main factors influencing an improvement in the acoustic performance of a roof:

- Use flat roofs as they are less exposed to road noise than pitched roofs
- Use parapets as they help to shield the roof from noise better than traditional eaves
- Increase the mass of the ceiling (or roof)
- Provide sound absorbent insulation material in the roof cavity
- Avoid gaps, as far as ventilation requirements will allow

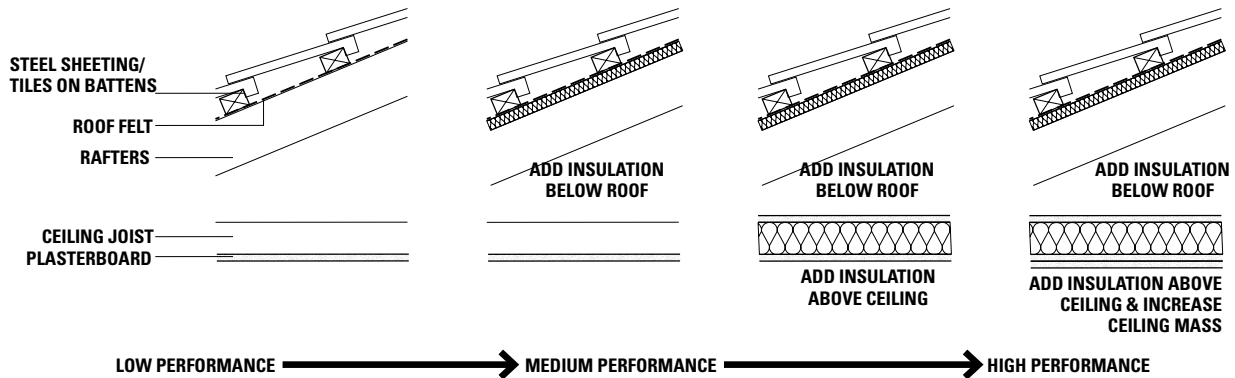

Figure 3.30: Roof acoustic insulation designs

3.8.7 Design to minimise adverse vibration and ground-borne noise impacts

A particular issue for development over tunnels (primarily rail tunnels) is ground-borne noise and vibration (see 3.6.2). Ground-borne noise level values are relevant where they are expected to be or are audible within habitable rooms.

Ground-borne noise is different from air-borne noise in that actions available to reduce or avoid adverse noise effects are more limited. Actions that can reduce the effects of adverse air-borne noise are likely to be relatively ineffective against ground-borne noise because the noise is emitted by the building structure itself.

The criteria for ground-borne noise will not ensure that this type of noise will be inaudible. However, a good level of amenity and protection from sleep disturbance will result if the criteria are achieved. Lower ground borne noise criteria (eg. 35 dBA) may be contemplated where acoustic amenity is a premium attribute in the area where development is to occur (eg. where background noise levels are low such as 30 dBA or below). To mitigate vibration and ground-borne noise, it is necessary to inhibit the transmission of the vibration at some point in the path between

railway track or road and the building. For many buildings, sufficient attenuation of ground vibration is provided by the distance from the road/track or by the vibration 'coupling loss' which occurs at the footings of the building. On other projects, these factors may not be adequate and consideration may need to be given to other vibration mitigation measures.

While the risk of excessive vibration is relatively low at distances greater than 50m from the source, the variation between ground types and building designs makes it difficult to provide generic guidance regarding additional mitigation. Specialist acoustic advice from a consultant with recognised expertise in groundborne noise and vibration is therefore recommended to determine whether vibration mitigation measures are necessary and what options are available for the particular project.

4 Air Quality near busy roads

4.1 HEALTH IMPLICATIONS FROM MOTOR VEHICLE AIR EMISSIONS

Vehicle exhaust emissions can have a significant influence on local air quality in urban and suburban areas of Australia. Localised effects can be caused as a direct result of the compounds emitted from vehicle exhausts. Secondary pollutants (eg ozone and photochemical smog) caused by a chemical reaction of the emitted pollutants can also occur where weather conditions are conducive and are of significance in terms of impacts over a wider regional area.

Motor vehicles emit a variety of air pollutants that are known to be associated with adverse health impacts. Common air pollutants emitted by motor vehicles include fine particles, nitrogen oxides, volatile organic compounds such as benzene, toluene, ethylbenzene and xylene (BTEX). Exposure to these substances at particular concentrations is associated with a range of short and long term health effects, including on the heart and lungs (WHO 2000, WHO 2003, NEPC 2002, Environment Australia 2001).

Air pollution studies have also identified vulnerable populations, such as children, people who are already ill and older people. Special consideration should be given to the air pollution environment of developments in urban areas that are used for a large proportion of the day by these groups.

Occupants of a dwelling, school, childcare centre, residential aged care facility, hospital, office or public recreational area are likely to be sensitive to emissions from vehicles.

Developments located next to busy roads have challenges in terms of how to provide an acceptable level of air quality for the occupants and users of the development. Although there can be different requirements for noise, energy-efficiency and air quality that need addressing at the design stage, there are also often common objectives and synergies. This section describes some of the principles that should be considered at the design stage to achieve improved air quality.

4.2 INFLUENCES ON AIR QUALITY

Patterns of pollutant concentrations vary from site to site and also over time. A wide range of factors influence the level of pollution including: vehicle mix, condition and technology; fuel quality; dispersion of pollutants across a carriageway; weather conditions and traffic flow. The quantity of air pollutants emitted from roads is directly proportional to the traffic volume, speed, and the speed variability (acceleration or braking) of vehicles. Motor vehicles emit fewer pollutants at steady speeds or in freely flowing conditions. They emit greater quantities when accelerating or decelerating, stopping and starting, when in congested traffic or while idling (*Quantification of Health Effects of Exposure to Air Pollution*, WHO 2000).

There are also emissions from diesel locomotives, particularly near busy rail freight corridors and intermodal terminals that predominantly use diesel locomotives.

4.3 WHEN IS AIR QUALITY LIKELY TO BE AN ISSUE?

4.3.1 Outdoor air circulation – wind and breezes

Areas that are not confined tend to have greater winds and breezes which in turn disperse and carry away air pollutants. The degree to which winds and breezes carry away air pollutants is influenced by the orientation and continuity of open spaces, their dimension and shape, topography and the layout of buildings surrounding the subject area. Roadway canyons for example, may channel winds or prevent them from reaching road level depending on their shape, dimension and orientation. The more confined a space is by buildings, walls or embankments adjacent to or over a roadway, the less opportunity air pollutants have to disperse.

Stepping back the upper storeys of roadside buildings increases dispersion of air pollutants and minimises the canyoning effect of tall buildings close to the road as depicted in **Figure 4.1**.

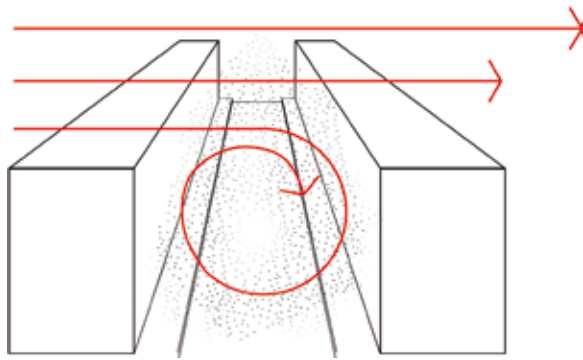

Figure 4.1: Roadway canyons and their effect on winds and air pollutants

As air flows around buildings and other obstacles, it creates zones of accelerated wind speeds and of reduced air circulation. Air pollutants emitted within a well-ventilated situation may be quickly dispersed, whereas pollutants trapped by buildings can become concentrated as depicted in **Figure 4.2**.

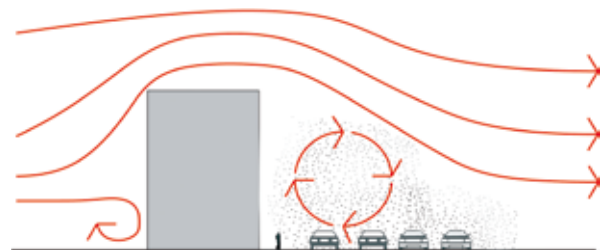
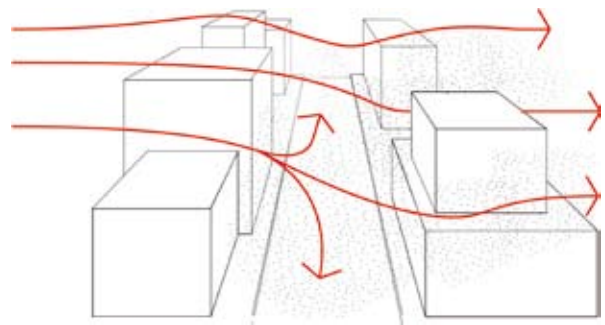

Figure 4.2: Buildings creating situations where air pollutants are trapped

At other times, with different atmospheric conditions, buildings may act as a barrier that shields and protects sensitive areas from high-emission zones as shown in **Figure 4.3**.

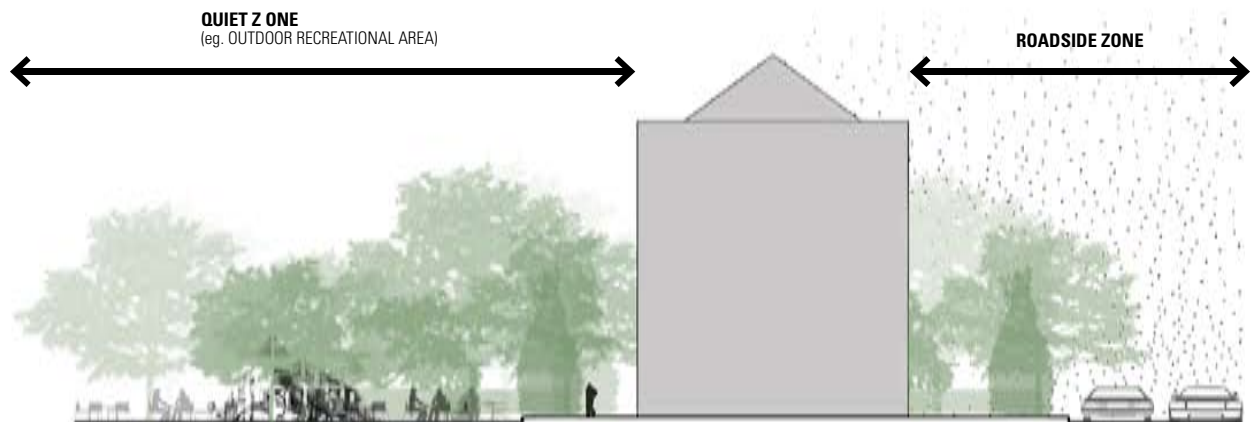

Figure 4.3: providing protection from air pollutants

4.3.2 Emission levels and proximity to carriageway

Broadly speaking, air pollution concentrations tend to be highest adjacent to the road and decrease with distance from it. For example, under the unfavourable dispersion conditions of temperature inversion and light winds (1 metre per second) where little mixing occurs in the atmosphere (termed F-class stability) pollutant concentrations can be expected to reduce by around 65 percent of roadside levels in the first ten metres from the road. Further reductions occur as the distance from the road increases (**Figure 4.4**). For higher wind speed and in the absence of

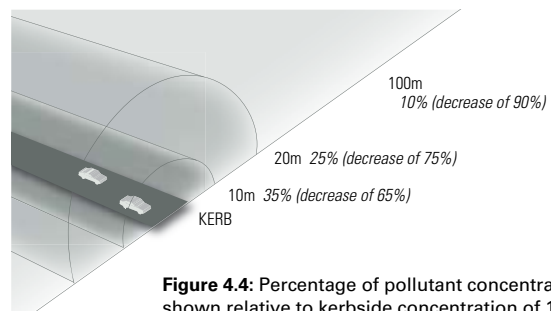

Figure 4.4: Percentage of pollutant concentration shown relative to kerbside concentration of 100%

temperature inversions pollutant concentrations fall more rapidly (ref – CALINE dispersion model USEPA).

4.4 MITIGATION LEVELS

4.4.1 Ventilation of indoor areas

Internal ventilation options:

- Natural ventilation – windows open to provide adequate ventilation.
- Passive acoustic ventilation – ventilators designed and fitted to provide adequate air movements.
- Mechanical ventilation – operating to provide suitable air exchange rates.

Where windows must be kept closed, the adopted ventilation systems must meet the requirements of the Building Code of Australia and Australian Standard 1668 – *The use of ventilation and air-conditioning in buildings*. Mechanical ventilation systems provide an opportunity for filtering external fresh air entering a building (eg carbon-filters or similar). Where possible, mechanical ventilation air inlet ports should be sited to maximise the distance from the road to reduce inflows of air pollutants.

4.4.2 Design considerations

With careful site planning and attention to detail, it is possible to incorporate many principles into a building or development to improve the air quality. Many of the techniques described throughout this Guideline are not only useful for noise reduction but also for improving air quality. At a micro scale, good acoustic planning and design measures discussed in Section 3 of this Guideline also provide air quality benefits. For example, external courtyard areas and internal rooms can be configured to minimise adverse noise impacts as well as minimise air pollution.

When air quality should be a design consideration:

- Within 10 metres of a congested collector road (traffic speeds of less than 40 km/hr at peak hour) or a road grade > 4% or heavy vehicle percentage flows > 5%,
- Within 20 metres of a freeway or main road (with more than 2500 vehicles per hour, moderate congestions levels of less than 5% idle time and average speeds of greater than 40 km/hr),
- Within 60 metres of an area significantly impacted by existing sources of air pollution (road tunnel portals, major intersection / roundabouts, overpasses or adjacent major industrial sources), or
- As considered necessary by the approval authority based on consideration of site constraints, and associated air quality issues.

Air quality design considerations :

- Minimising the formation of urban canyons that reduce dispersion. Having buildings of different heights interspersed with open areas, and setting back the upper stories of multi-level buildings helps to avoid urban canyons.
- Incorporating an appropriate separation distance between sensitive uses and the road using broad scale site planning principles such as building siting and orientation. The location of living areas, outdoor space and bedrooms and other sensitive uses (such as childcare centres) should be as far as practicable from the major source of air pollution.
- Ventilation design and open-able windows should be considered in the design of development located adjacent to roadway emission sources. When the use of mechanical ventilation is proposed, the air intakes should be sited as far as practicable from the major source of air pollution.
- Using vegetative screens, barriers or earth mounds where appropriate to assist in maintaining local ambient air amenity. Landscaping has the added benefit of improving aesthetics and minimising visual intrusion from an adjacent roadway.

Part D: Potential impacts of adjacent development on roads and railway

Development near rail corridors and busy roads can impact on the structural integrity of the infrastructure and engineered structures. For electrified railways there are significant additional safety issues associated with electrocution and corrosive effects of electrolysis. This Part identifies these and other key safety and engineering issues.

5 Safety and Design Issues

5.1 ESSENTIAL EARLY REQUIREMENTS

5.1.1 Safe design practices

A safe design approach begins in the conceptual and planning phases with an emphasis on making choices about design, materials used and methods of construction. Safe design will always be part of a wider set of design objectives, and is the process of successfully achieving a balance of these sometimes competing objectives, without compromising health and safety.

Safe design is:

- The integration of hazard identification and risk assessment methods early in the design process to eliminate or minimise the risks of injury. It encompasses all design including facilities, hardware, systems, equipment, products, tooling, materials, energy controls, layout and configuration.

Source: Australian safety and Compensation Council (2006) Guidance on Principles of Safe Design for Work.

For works undertaken within or adjacent to the rail or road corridor, authorities have strict safety standards and procedures that are required to be met to ensure that any works do not threaten the safety or operational capacity or efficiency of the rail network. Design should also ensure that risks to property are eliminated or minimised.

Rail Corridor inherent dangers or risks:

- The movement of trains at high speed that require lengthy stopping distances.
- Critical safety and signalling systems that operate the movements of trains.
- The presence of high voltage cables and overhead wiring with electrified trains.

5.1.2 Early consultation with road and rail authorities

It is always advisable to undertake early consultation with the relevant infrastructure authority when planning a development next to road or rail infrastructure. The design and safety issues (refer below) can then be identified and incorporated at an early stage reducing the need for ongoing iterations, costs and delays. Further, a proponent would also be able to determine the need for expert advice and input into the development design, such as geotechnical investigations.

5.1.3 Survey Information

When a development is within or adjacent to a road or rail corridor a detailed plan should be prepared by a qualified land surveyor, to determine the location of the site in relation to existing and proposed road and rail infrastructure.

Surveys should identify:

- The boundaries of the development site in relation to the adjacent busy road or rail corridor.
- Easements and encumbrances related to the protection of road or rail infrastructure (eg to protect overhead transmission lines, underground pipes or rights of way for access to the corridor).
- Location of road or rail tunnels.
- Location of rail corridors under the metropolitan rail expansion program (cl 87 Infrastructure SEPP).

The proponent should undertake a services search with the rail or road authority to identify the location of services to ensure that the proposal meets clearance requirements for any underground high voltage cables.

5.2 ELECTROLYSIS

Electrolysis is an electro-chemical reaction involving an electrolyte and metals. With rail networks, the electrolysis results from ground leakage of the electrical current which powers the train from 1500 volt overhead wires. This stray or leakage current can then cause accelerated corrosion of nearby metallic structures.

5.2.1 Why is electrolysis an issue?

Accelerated and potentially dangerous metallic corrosion can be caused by electrical leakage electrolysis as described above and/or the simple atomic electrical potential differences between materials (see **Figure 5.1**).



Figure 5.1: Example of corrosion caused by electrolysis

Electrolysis can:

- weaken the structural integrity of buildings or structures by corroding beams or rivets
- corrode gas, sewage or water pipes or electricity cables causing leakages and related damage, and
- lead to accelerated deterioration of metal finishes (eg. balcony railings, window frames, awnings).

5.2.2 Avoiding or minimising electrolysis damage

Electrolysis and related corrosion can be minimised by selecting suitable building materials and avoiding using metal finishes in the vicinity of high voltage electricity. Using masking agents or coatings to prevent exposure of metals or prevent direct contact between metallic parts will also assist in preventing the effects of electrolysis.

Proponents should obtain appropriate advice on avoiding electrolysis, including through early consultation with the rail authority and assessing whether preventative measures are required.

Typical measures to prevent or minimise the effects of 'stray current' electrolysis from electrified railway include:

- Keep metallic services such as pipelines away from tracks.
- Insulate from earth all water and gas pipes and power or communications cables with metallic sheaths laid near the track or along the rail corridor.
- Ensure that there are no long lengths of metallic water, gas or other pipes laid in or adjacent to the rail corridor.
- All water and gas pipes servicing buildings on the rail corridor and near the track to have an isolating joint installed at the boundary.
- All low voltage supplies using isolating transformers, local electricity distributor neutral and earthing systems should not enter the rail corridor.
- Use isolating joints to divide any buried structure into short lengths.
- Use insulating coatings.
- Metallic lineside fencing should have insulating panels installed every 500 metres.
- Lineside fencing should not be connected to fencing at electrical substations or railway stations.
- Concrete poles should not be used on the railway corridor and near the rail track. Local electricity distributors should be advised not to use concrete poles near rail track, particularly if overhead earth wire or neutral wire is fitted.
- All metallic structures such as footbridges, bus shelters and sheds should be isolated at the boundary of the rail corridor, e.g. by installing two gaps in the steelwork, 2 metres apart. Particular care is needed if there is lighting installed to ensure that the local electricity distributor's earth is not connected to the steelwork which forms part of any overhead wiring structure, station or bridge.
- If necessary utilise Corrosion Protection Systems consistent with Australian Standard *AS 3832 Cathodic protection of metals (Parts 1-4)*.

Source: RailCorp (2002)

5.3 CRANES

The use of cranes is common practice in construction, particularly where it is proposed to erect multi-storey developments. Concrete pumping equipment involving pumps, booms and pipe networks are also common practice in building construction as they can pump concrete over barriers, around corners and have aerial applications in multi-storey developments.

Cranes, concrete pumps and other equipment capable of moving into or across the airspace above rail corridors and busy roads may therefore cause safety and other issues if their operation is not strictly managed.

Aerial movements in proximity of busy roads and rail lines can cause:

- Loss / failure of loads with safety implications and resultant impacts on road and rail infrastructure.
- Overbalancing of crane or other equipment used in the aerial movements causing blockage of road and rail corridors with the potential for collisions or derailments.

Aerial operations in proximity to overhead wiring and other electrical sources can cause:

- Electrical arcing and potential electrocution of workers
- Power outages as a result of arcing, causing potential cessation of services
- Failure and collapse of overhead wiring with resultant safety risks to rail passengers, rail authority staff, crane operators and other workers, and cessation of rail services



Figure 5.2: Example of crane overbalancing into the rail corridor

5.3.1 Specific requirements for cranes and other aerial equipment in the road or rail corridor

A crane, concrete pump or other equipment must not be used in airspace over the rail corridor without approval in writing from the rail authority. No loads should pass over overhead wiring or transmission lines located within the corridor at any time. Proposed aerial movements may require power outages or track possession for the period of the proposed airspace movement and therefore the relevant authority should be contacted at the earliest opportunity. Minimum working clearances to exposed electrical equipment within the corridor should also be adhered to (refer 5.11).

All concrete pumps, cranes, hoists and winches must be used in accordance with the AS 2550 series of Australian Standards, *Cranes, Hoist and Winches*, including AS 2550 15-1994 *Cranes – Safe Use – Concrete Placing Equipment*.

5.4 SAFE ACCESS FOR MAINTENANCE

In the building design, consideration should be given to how future maintenance will be undertaken safely, including window cleaning, painting and building repairs. It should also be possible for a building to be maintained so that workers and equipment can meet the minimum electrical safety clearances necessary (refer 5.11).

5.5 STORMWATER MANAGEMENT

The discharge of stormwater from a development, during and after construction, can potentially impact on road or rail infrastructure. In addition a development proposal may affect existing watercourses and drainage infrastructure and change run-off behaviour.

Additional and unmanaged flows can:

- undermine support structures and overhead wiring structures (in the case of rail)
- damage electrical power and signalling systems
- deteriorate tunnel linings
- damage equipment, and
- have particular safety implications where flash flooding occurs.

Drainage systems should be designed so that stormwater is captured on site for reuse or diverted away from the road or rail to the council drainage system ensuring that existing drainage is not overloaded.

Building design should ensure that gutters and balcony overflows do not discharge into road

or rail infrastructure. Where drainage into the transport corridor is unavoidable due to site characteristics, discussion should be held early on with the road or rail authority. If upgrades are required to the rail or road drainage system solely due to adjacent development, the costs involved should reasonably be met by the proponent. All disturbed surfaces must be stabilised consistent with *Managing Urban Stormwater: Soils and Construction* (Landcom 2004) ('the Blue Book').

5.6 VANDALISM

Measures should be considered at the design phase to minimise risks from vandalism involving objects being thrown onto passing vehicles and trains, or into the rail or road corridor. This action can have safety implications for vehicle occupants, rail passengers and rail authority staff. There are also repair costs associated with infrastructure damage coupled with transport delays as facilities are repaired and, in worst case scenarios, as accidents are cleared.

Recommended measures to avoid vandalism:

- Consider measures at the design stage to minimise opportunities for vandalism.
- Pedestrian bridges, walkways, open balconies and windows should preferably be a minimum of 20 metres from busy roads or rail lines
- Where pedestrian bridges, walkways, open balconies and windows are less than 20 metres from a road or rail line AND face the road or line:
 - design pedestrian bridges and walkways with high degree of surveillance or railings to limit opportunity for vandalism
 - enclose balconies
 - install louvred windows or restricted window openings
 - restrict all opening windows to maximum of 80 millimetres.

5.7 GRAFFITI

Graffiti and related defacement of surfaces can become an issue along some busy roads and railway corridors. The costs of surveillance, physical removal and repair can cost many hundreds of thousands of dollars on an annual basis. Removal may also interrupt rail operations and cause delays on busy roads (see **Figure 5.3**).



Figure 5.3: Graffiti

Recommended measures to avoid graffiti:

- Consider measures at the design stage to avoid the need for costly removal measures later
- Treat fencing and other surfaces with anti-graffiti paint or coating materials
- Landscape to reduce visual exposure to graffiti-ists – any vegetation should avoid affecting the visibility of train drivers or road users and not have expansive root systems

5.8 LIGHTING, EXTERNAL FINISHES AND DESIGN

Lighting and external finishes of buildings which face roads or the rail corridor may affect the safety of road and rail operations if potential impacts are not adequately taken into account in the building design and the selection of materials and colours.

Temporary blinding effects or distraction caused by lighting, glare from reflective surfaces and signs which face the road and rail corridor, particularly around sunrise and sunset can cause safety issues.

Recommended measures associated with lighting and external finishes:

- Consider potential impacts at the design stage taking into account site aspect, shadowing and the pattern of sun movement
- Where possible, avoid reflective finishes (metal, glass) on facades which face the rail or road corridor
- Use non-reflective walls, additional landscaping and screenings as additional line-of-sight measures
- All outdoor lighting should adhere to AS 4282-1997 *Control of Obtrusive Effects of Outdoor Lighting*

Specific lighting requirements for the rail corridor:

Red and green lights which are used in signalling systems should be avoided in all signs, lighting or building colour schemes on any part of a building which faces the rail corridor.

5.9 STRUCTURES IN THE RAIL CORRIDOR

Structures within the rail corridor or which interface with the rail network must be designed and constructed to be consistent with the necessary standard. Structures with particular requirements include: overbridges, footbridges, tunnels, retaining walls, air space developments and overhead loading structures.

Standards for structures within or which inter-face with the rail corridor:

- Undertrack structures, road bridges, footbridges: AS 5100.2-2004 Bridge Design – Design Loads
- Utility services – relevant Australian Standards

5.10 DERAILMENT PROTECTION OF STRUCTURES

In the design of buildings or structures either within or adjoining the rail corridor, the potential risks from a possible derailment should be considered. Sites within the corridor straddling rail lines, or outside the corridor adjacent to curves on high speed tracks or at rail line junctions are at a higher risk. The need for derailment protection must be considered for the design of piers, columns and structures within or which interface with the corridor.

The results of this risk analysis may mean that simpler and less costly devices such as earth mounds, gabions, guard railings etc. may be permitted to provide protection. However, even if the analysis indicates a low probability of risk, provisions may be required to include in-built deflection resistance to the proposed structure.

Piers, columns, building and structures within or adjoining corridors:

- Must have a risk assessment undertaken which should consider the following criteria:
 - Site condition, presence of cuttings or embankments and any other characteristics of the site.
 - Derailment history of the site.
 - The type of proposed structure to be erected, including any potential for collapse and consequent damage to trains and other infrastructure.
 - Track geometry and its likely effect on the proposed work.
 - Track speed and whether this represents a risk to the integrity of the proposed structure
 - Type of rolling stock utilising the track
 - Demonstrate compliance with the principles contained in RIC Standard; TS 30 000 3 01 SP or Design Standards BDS 06 for ARTC

5.11 ELECTROCUTION – OVERHEAD WIRING

Electrified rail infrastructure has overhead power systems and related cabling and cable support structures. Poles, masts, signals and substations all have power cabling associated with them. Significant safety issues associated with these electrical systems include risks of electrical arcing and potential electrocution.

Overhead power system cables (1500 volts) for the metropolitan rail network can remain live even when they have shorted or fallen onto the rails and they can arc up to 1 metre (RailCorp 2005). Contact with overhead powerlines can lead to a variety of hazardous conditions including unpredictable cable whiplash and the electrifying of other objects such as signs, poles, trees or branches (WorkCover 2000). Workers, tools, equipment (eg. metal ladders and measuring tapes), cranes and scaffolding can all pose safety risks if they are used within safety clearance distances of any electrified infrastructure or exposed electrical equipment.

Minimum electrical safety distances to protect workers and equipment which should be adhered to:

- Work clearances to rail cables and structures: 8 metres.
- Travelling work clearances to rail cables and conductors: 4.6 metres.
- At any time, workers, tools, equipment and material should not come within 2 metres of exposed low voltage, 1500 volt DC overhead wiring or any high voltage equipment.
- No metal scaffolding or ladders within 6 metres of exposed 1500 volt DC or high voltage equipment.
- No cranes within 3 metres horizontally to any electrified infrastructure or within the vertical envelope (see also 5.3).
- No metal measuring tapes within 3 metres of exposed electrical equipment.
- No excavation within 3 metres of poles, masts or rail signals.

5.12 UNDERGROUND ELECTRICAL SERVICES

Underground electrical cables also pose safety risks and risks to the integrity of the rail network if excavation or boring works cut or damage cables or other services. Any excavation works including horizontal or vertical boring or pile driving should avoid areas where there are existing underground electrical and other services.

Actions and minimum clearances to underground electrical and other services are:

- Undertake an underground services search for electrical, gas, water, sewer, stormwater and telecommunications and provide written report as part of the Development Application (DA) prior to any excavation works commencing
- No electrical or other services are to be permitted within 1.6 metres of the underside of the rail level (and a buffer of 4 metres is preferred where possible) or comply with AS4799, whichever is greater
- No excavation or boring within 2 metres (horizontal) of HIGH voltage underground electrical cables
- No excavation or boring within 1 metre (horizontal) of LOW voltage underground electrical cables

5.13 TRACK CLOSURES, POWER OUTAGES AND CORRIDOR ACCESS

The construction method for a development should ensure that it does not interfere with train operations. In those limited cases where unavoidable, certain phases of construction or excavation may require access to the rail corridor and the rail authority to stop trains running on adjoining tracks (track possession) and/or shutting off the power (power outage). Proposed track possession or power outages will have significant impacts on rail operations which will be unable to operate on the section of the rail line for that period of time. For this to occur safely and minimise impacts on rail operations early discussions must be held with the rail authority.

An agreement (e.g. Deed, Local Possession Authority) must be entered into with the rail authority enabling this work to be planned and proceeded with in a safe and timely manner. The agreement will define required involvement of rail staff and the controls which will be implemented in managing the access and/or the potential impacts on rail facilities.

5.14 LEVEL CROSSINGS

Level crossings (refer **Figure 5.4**) are where a rail line crosses or intersects with a road (an 'at-grade intersection') in the absence of a bridge or tunnel and can be a significant danger to both road and rail users.

There are more than 3800 railway crossings in NSW, with at least 1500 being public rail/public road crossings (Level Crossing Strategy Council). Protection for road users varies from 'passive' signage to 'active' protection (bells, lights or boom gates).



Figure 5.4: 'Active protection' at a level crossing

5.14.1 PLANNING CONSIDERATIONS FOR LEVEL CROSSINGS

New level crossings are to be avoided wherever possible because of their inherent safety risks (Level Crossing Strategy Council). Alternative arrangements should always be explored first prior to the option of a new crossing being considered.

Each railway crossing has a risk profile on the basis of a number of factors

Factors for Level Crossing risk profile assessment:

- Visibility - how well motorists can see on-coming trains;
- The existing protection at the crossing;
- The frequency of trains passing through the area;
- The number of tracks;
- The volume and type of road traffic over the crossing;
- Nearby road geometry; and
- Potential for motorists to queue on the crossing.

Source: Level Crossing Strategy Council

Residential, commercial or industrial development may change the risk profile of a crossing where there is likely to be:

- an increase in traffic on the crossing as a result of the development, or
- if there will be a change in the type of traffic use, such as an increase in the proportion of heavy vehicles.

Predicted changes to the risk profile of a crossing must therefore be taken into consideration by a consent authority when it is assessing a development application.

Infrastructure SEPP requirements (refer clause 84):

Where a development involves a new level crossing, the conversion of a private access road across a level crossing into a public road or where the development is likely to significantly increase the total number of vehicles or number of trucks using a level crossing in the vicinity of the development, the Infrastructure SEPP requires that a consent authority must take into consideration:

- The implications for traffic safety including the costs of ensuring an appropriate level of safety having regard to the existing traffic characteristics and any likely change in traffic affecting the crossing as a result of the development, and
- The feasibility of alternative means of access to the development that does not involve use of level crossings and
- Any comments received from the CEO of the rail authority on the proposal.

The consent authority must not grant consent for the development without the concurrence of the CEO of the rail authority. In determining whether to provide concurrence, the CEO of the rail authority must take into account:

- Any rail safety or operational issues associated with the aspects of the development, and
- The implications of the development for traffic safety including the cost of ensuring an appropriate level of safety, having regard to existing traffic and any likely change in traffic at level crossings as a result of the development.

Note: traffic includes rail, road and pedestrian traffic

5.15 FENCING

The security of fencing along the rail corridor is essential to prevent unauthorised entry. Given the frequency and speed of trains, particularly in built up areas, unauthorised entry is a key safety risk and has the potential to disrupt services.

Where construction activity occurs near existing rail-side fencing, provisions should be made to prevent damage to fencing. In instances where new metallic rail-side fencing is proposed, it could be affected by electrolysis (refer section 5.2).

6 Excavation, earthworks and other construction related issues

6.1 INTRODUCTION

Development adjacent to rail corridors and busy roads or over existing tunnels has the potential to impact on safety and the operation of the road/rail network. Road and rail infrastructure both above ground and underground (ie tunnels) can include a wide range of engineered structures, facilities or buildings which may be affected by proposals to build or carry out excavation and other adjacent earthworks.

Terminology:

- **Excavation and earthworks** include excavation, filling and construction of retaining walls
- **Excavation** refers to any artificial cut, cavity, trench, void or depression in soil or rock created by soil or rock removal. It includes foundation works involving penetration of the ground by boring, pile driving or pile drilling.
- **Filling** includes foundation preparation and placement of fill both compacted and loosely placed.
- **Retaining** includes design and construction of structures required to retain soil, rock and other materials.

Although this section of the guideline is directed at work within or adjacent to a rail corridor, the majority of the issues are also directly applicable to work on, or adjacent to, road corridors.

Excavations and other earthworks in or adjacent to rail corridors also require concurrence from the road and relevant authority where the specific requirements of the Infrastructure SEPP are met.

Clause 86: any development (other than development to which clause 88 of the Infrastructure SEPP applies) that involves the penetration of the ground to a depth of at least 2m below ground level (existing) on land that is:

- a) within or above a rail corridor; or
- b) within 25m (measured horizontally) of a rail corridor; or
- c) within 25m (measured horizontally) of the ground directly above an underground rail corridor

Note: the consent authority must not grant consent without consulting with the rail authority and obtaining concurrence consistent with clauses 86(2)–(5)

Clause 103: any development which involves penetration of the ground to a depth of at least 3m below ground level (existing) on land that is the road corridor of roads or road projects as specified in schedule 2 of the SEPP.

This guideline assists in the preparation of information for seeking concurrence (details of rail authority concurrence process is in Appendix A).

6.2 WHEN ARE EXCAVATIONS AND EARTHWORKS LIKELY TO BE A KEY ISSUE

6.2.1 Excavations and other earthworks adjacent to road and rail corridors

Excavations, other earthworks and building construction adjacent to rail corridors and busy roads can have implications for the integrity of the transport system and its engineered structures and can increase safety risks if not appropriately designed, planned and managed. Poorly designed and implemented excavation, earthworks and construction can cause subsidence, deterioration of existing structures and can cause stress changes in the soil and rock. This may be a particular problem where excavations are deep, the on-site substrate (soil or rock) exhibits poor compressive strength, contains structural defects or there is groundwater seepage.

Potential problems associated with excavations include slippage, slumping, creation of fissures or cracks, rock or earth falls, exacerbated ground movement, water inflows and, in a worse case scenario, structural failure may occur.

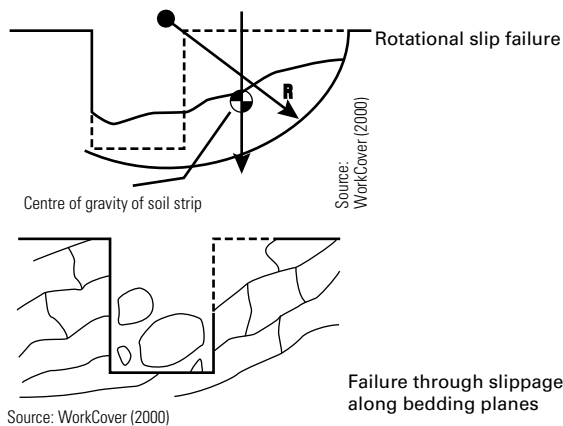

The specific design of a proposal to build or excavate in and around the corridor or over tunnels should include and take into consideration:

- Site location of the proposed development or works.
- Location of property and title boundaries and easements, including for tunnels.
- Searches for existing road, rail and other underground, aerial and surface services.
- Site layout –the proposed works within the site and its relationship to any adjoining property.
- Proposed site excavation and service layouts including details of size, construction methods and depths.
- Consideration of noise and vibration by referring to the NSW Construction Noise Guideline (DECC 2008)

Filling and retaining walls can cause settlement of the ground and stability problems can occur with the fill and wall foundations. Fill and retaining wall construction can obstruct site lines if located on the inside of a curve. Stormwater runoff and erosion of new fill slopes can also be a problem.

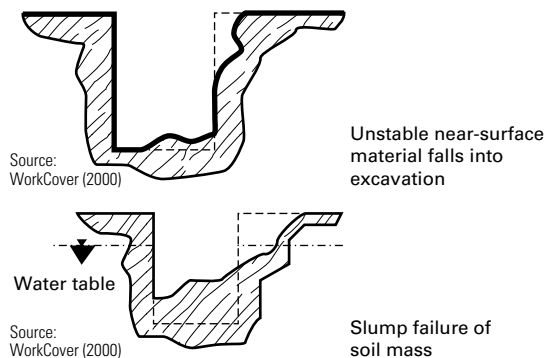

6.2.2 EXCAVATIONS AND OTHER EARTHWORKS ABOVE TUNNELS

Road and rail tunnels are an integral part of the transport network, particularly within the Sydney CBD. Key issues are discussed below.



Load bearing issues for tunnels:

- Excavation, earthworks and construction above tunnels can vary loadings within the soil and rock column above the tunnel void and cause changes in stress fields. Stress release (due to basement excavation) and stress increase (due to the new building foundations, filling or retaining) alter the stress distribution in the ground beneath the building and on the underlying tunnel. Deep excavations to construct foundations for high rise buildings or establish basement car parking are particular risk factors.
- Stress field changes can cause adjustments in the rock body particularly where there are existing fissures or planes of weakness. Loadings on the rock envelope around a tunnel can lead to changes in tunnel shape and a potential reduction in the tunnel's margin of safety against structural failure.
- Vibration and other ground movement associated with rock breakers, boring, pile driving, pile drilling and sinking of piers may affect the soil and rock column above a tunnel. This can be an issue where the rock contains interbedded strata of variable strength, where excavations are deep or where the tunnel roof is at a relatively shallow depth.

Maintaining the integrity of the tunnel lining and support of the tunnel and caverns

- In deep excavation or where the tunnel is close to the ground surface, there can be a risk that boring and pile installation may pass close to or physically intersect tunnel linings or tunnel/cavern supports. This can also occur during exploratory drilling at the pre-excavation stage including where the excavation is not vertically above the tunnel but angle drilling is involved. 'Vertical' boreholes can "wander off" vertical possibly unexpectedly encountering tunnels some horizontal distance away from the drilling location.
- Physically intersecting tunnel linings may affect the structural integrity of the lining, affect the function of the tunnel and cause safety issues where there is penetration into the tunnel void itself. Water inflows, rockfalls and roof failure can directly affect safety and operations. Potential intersections of the boring equipment with live electrical infrastructure may also be possible with resultant risks of electrocution and power outages.
- All these effects can lead to damage of the tunnel structure (ring elements, bolts, etc.) and distortion of the tunnel shape and alignment. For rail tunnels, tilting or changes in cross-fall of tracks increases the risk of a train derailment. Changes in the tunnel profile may restrict the ability of a train to run through the tunnel without hitting the tunnel with significant safety and service implications as a result.

Effect of tunnel condition

- The consideration of future loads will depend on the condition of the tunnel and track and geotechnical conditions, so a condition survey is required prior to any works commencing. The complexity of the design analyses required will depend on how the development might impact on the existing engineering safety limits of the tunnel.

6.3 AVOIDING IMPACTS BY GOOD PLANNING AND DESIGN

To ensure that the impacts of excavation on road and rail infrastructure are minimised, careful design and planning should ensure that the following key aspects are considered when proposing to build or carry out excavations and other earthworks in and around rail corridors and busy roads.

Key considerations for excavations and earthworks

- Geotechnical aspects of the site are identified and assessed and are a major basis for the design of the excavations, earthworks and construction works.
- The restricting geotechnical factors on tunnels from construction works are within acceptable limits, eg for additional pressure (loading), predicted movement (lateral shift, distortion) and vibration.
- The location of existing underground, aerial and surface utilities/services, including transmission lines, cables and pipelines are identified and considered in the design of the works.
- The specific locations of existing infrastructure including tunnels, structures, foundations, embankments, retaining walls, cuttings and presence of existing rock bolts and anchors are identified and taken into consideration in the design.
- Dilapidation surveys identify the current state of facilities in and around the site, particularly the existence of cracking, corrosion or evidence of other deterioration.

6.4 WHEN IS AN ASSESSMENT NEEDED

Geotechnical assessments for developments involving excavation and other earthworks will be required if located in the vicinity of a rail corridor or busy road as follows:

Excavation under the Infrastructure SEPP

- Where the following clauses apply: 86 and 103 (refer page 2)

Filling/retaining in other situations

- If the distance between the toe of the fill, or retaining structure, and the rail corridor boundary is less than twice the height of the fill/retaining structure.

If applicants are unsure about the likely impact of an excavation, it is best to obtain preliminary geotechnical advice to determine whether the development can comply with standard conditions or whether additional measures are necessary.

6.5 WHAT ARE THE ASSESSMENT REQUIREMENTS

6.5.1 General

There are specific engineering and other technical requirements that need to be addressed associated with any proposed excavation works adjoining rail corridors and busy roads or above an existing tunnel to ensure that impacts are minimised. When lodging a DA, a report must be submitted that addresses the geotechnical issues on the following page and include a construction methodology and numerical modelling based on evidence acquired through geotechnical investigation. There are also concurrence requirements to the relevant rail authority under clauses 84, 86 and 88 of the Infrastructure SEPP (refer to Appendix A).

Issues to be considered during site investigations and geotechnical assessment associated with excavation, earthworks or building adjacent to a rail corridor/busy road or over an existing tunnel:

- Site topography, geology and hydrology.
- Climatic influences including prevailing weather conditions and seasonal variations.
- Groundwater investigations.
- A dilapidation survey including location, condition and influence of existing structures, services and old workings.
- Presence of possible geotechnical hazards such as unstable slopes, evidence of landslip or rockfall.
- Site soil and rock properties (e.g. strength of soil and rock materials, extent of any rock weathering, presence of existing rock fractures, joints and other planes of weakness, in situ existing rock stress field magnitude and orientation).
- Expected induced rock stress field due to the proposed excavation.
- Expected changes to restricting geotechnical factors on any existing tunnels such as additional pressure (loading), predicted movement (lateral shift, distortion) and effects of excavation or building induced vibration.
- Potential rock failure mechanisms within the rock mass.
- Expected blast damage effects to the rock mass if blasting is being considered.
- Likely scale and nature of the ground response to the proposed excavation works (likely movement) and potential effects on adjoining buildings or installations.
- Presence of possible contaminated environments – such as contaminated soil or contaminated groundwater such as by chemical plumes.
- Proposed approaches/measures to mitigate predicted impacts.
- Previous relevant experience and historical data for the area.
- Strength/compressibility of fill and retaining wall foundations.
- Stability of proposed fill slopes.

Source: WorkCover 2006

Site investigations may include mapping, borehole drilling, drill core testing, structural surveys, underground surveys, test pits, collection and testing of samples of groundwater, rock, soil, and structural materials.

To assist in the specifications of geotechnical assessments associated with excavations, relevant Australian Standards should be followed as applicable, including:

- AS 4133.0 – 2005 Methods for Testing Rocks for Engineering Purposes – general requirements and list of methods;
- AS 1289.0 - 2000 Methods for Testing Soils for Engineering Purposes; and
- AS 1726 – 1993 Geotechnical Site Investigations (contains standards for planning and designing investigations, methods, reporting and technical aspects such as description and classification of soil and rock for geotechnical purposes).

Suitable guidance associated with the assessment can be found at the Australian Geomechanics Society: <http://www.australiangeomechanics.org/index.htm>

Geotechnical assessment should be undertaken by a suitably qualified geotechnical engineer or engineering geologist who is:

- Listed on the National Professional Engineers Register Level 3 (NPER-3) or a current member of Fellow of the Australian Institute of Geoscientists, and;
- Has a minimum of 5 years working experience as a geotechnical engineer or engineering geologist advising on building and excavation works and associated geotechnical issues.

6.6 TYPICAL EXCAVATION AND EARTHWORKS MANAGEMENT ISSUES

Once the geotechnical assessments have been undertaken, suitable ground support systems can be designed to ensure the integrity of the excavation, any underlying tunnels, adjoining infrastructure and any nearby buildings and structures whilst also ensuring the safety of workers during excavation works. Controls on cutting can include passive measures such as benching or battering of the excavation walls and active measures such as shoring and other support systems (see below).

Controls on fill and retaining wall foundations can include ground improvement to remediate weak or compressible ground such as undercutting soft soils, placing stone columns, dynamic compaction or using basal reinforcement. Fills may also require erosion protection of newly placed or easily erodable fill slopes. Sediment control on adjacent excavations and other earthworks such as settling ponds, and silt fences will be required to limit/prevent sediment runoff affecting the road/rail corridor.

6.6.1 Benching or battering

To assist in minimising the risk of soil or rock material falling or slipping into an excavation, the excavation walls can be benched or battered depending on the geotechnical assessment of the site (see **Figures 6.3a** and **6.3b**).

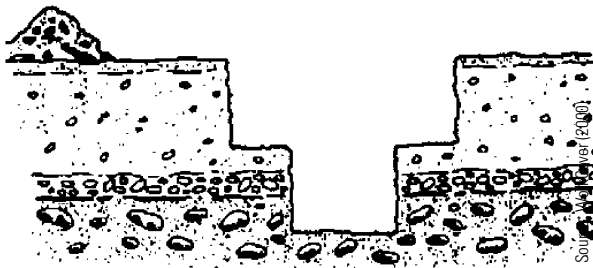

Figure 6.3a: Benching

Benching involves the establishment of stepped benches to the excavation wall and is used to reduce the vertical height of the excavation wall (see **Figure 6.3**). A geotechnical risk assessment is required to determine the specifications of the benches to ensure stability of the excavation wall.

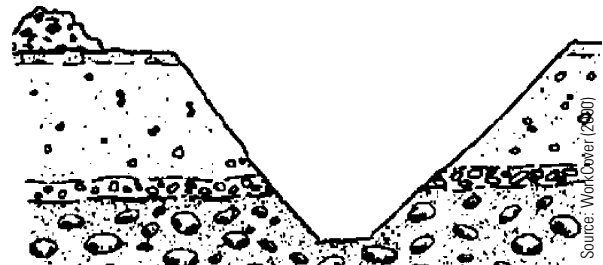

Figure 6.3b: Battering

A batter involves sloping the excavation wall back to an angle which ensures stability. Again a geotechnical assessment is required to determine this angle. In some situations a combination of a bench and batter may be suitable (WorkCover 2000).

6.6.2 Excavation support systems

Excavation support systems such as shoring are temporary earth retaining structures that allow the sides of an excavation to be cut vertically or nearly vertically. Retention systems may use rock bolts, ground anchors or soil nails to resist the lateral earth and rock pressures. Where adjacent structures require stabilisation, foundations should be protected, strengthened or underpinned and lateral loads supported as excavation proceeds, depending on the geotechnical conditions of the site.

Factors that should be considered in the design of a suitable system include:

- The size and strength of the component members of the shoring.
- Existing and changing ground conditions including drainage.
- The loads and types of ground or soil conditions to be shored.
- Static loads near the excavation such as spoil piles, buildings and structures.
- Dynamic loads near the excavation such as traffic and excavation equipment.
- Ground vibration such as from heavy traffic, mobile plant, trains, pile driving and blasting.
- Undermining of roads, footpaths, buildings and other structures.
- Difficulties or risks that other services may pose such as overhead power lines, existing or proposed underground services.
- Working environment such as exposure to dust, fumes, gases, noise, water, contaminated atmosphere or contaminated soils.
- Systems of work are accordance with any legislative requirements.
- Location of utility services.
- Safety issues during installation and removal of the systems.

(after WorkCover 2000)

From an OH&S perspective (*WorkCover NSW Code of Practice – Excavation*), it is a legal requirement that where necessary all excavations must be adequately shored or otherwise supported to prevent a fall or dislodgement of earth, rock or other material forming the side of or adjacent to any excavation work from burying, trapping or striking a person that is in the excavation. Where a similar risk also exists for the support installers, other measures must be in place to ensure their safety.

An excavation support system is not required if, having regard to the nature and slope of the side of the excavation and other relevant circumstances there is no reasonable likelihood that earth, rock or other material will fall or dislodge from a height of more than 1.5 metres and bury, trap or strike a person that is in the excavation. The risk assessment process should be used to identify unstable conditions and the risks involved (WorkCover 2000). Support of an excavation should proceed as the work of the excavation progresses.

Types of excavation support systems (see Figure 6.4) include, but are not limited to:

- Sacrificial sets which stay in the ground indefinitely and may be concrete, timber or other materials.
- Soldier sets – timber, steel.
- Full timber systems with runners and horizontal rails.
- Trench supports such as shields, cages or boxes.
- Sheet piling.
- Pre-cast panels.
- Diaphragm walls.
- Rock bolts and ground anchors.
- Caissons.
- Sand bags comprised of a sand cement mix.
- Hydraulic systems.
- Soil nails and shotcrete.
- Pneumatic systems.

Source: WorkCover (2000)

All excavation support systems should be designed and constructed consistent with the requirements of Australian Standard AS 4678 – 2002 *Earth-retaining Structures*.

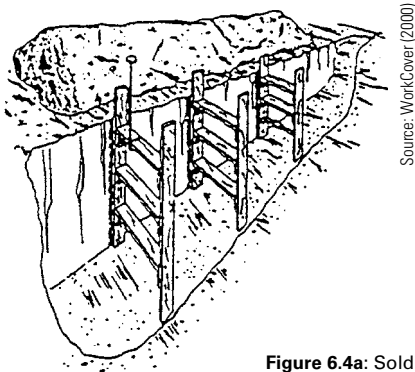

Source: WorkCover (2000)

Figure 6.4a: Soldier sets

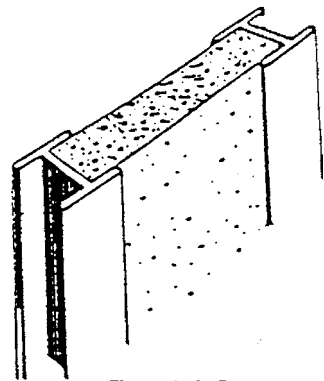

Source: WorkCover (2000)

Figure 6.4b: Pre-cast panel

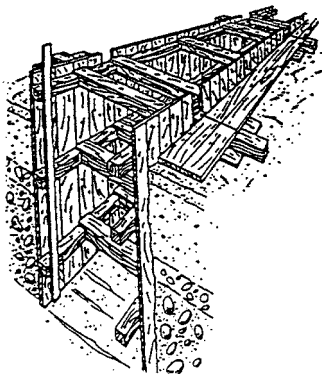

Source: WorkCover (2000)

Figure 6.4c: Full timber system

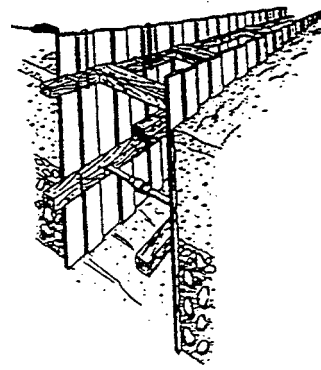

Source: WorkCover (2000)

Figure 6.4d: Sheet piling

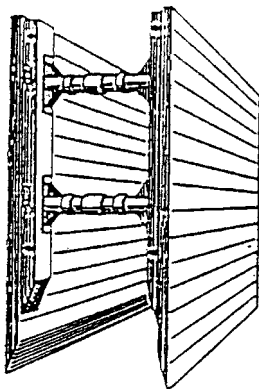

Source: WorkCover (2000)

Figure 6.4e: Trench shields

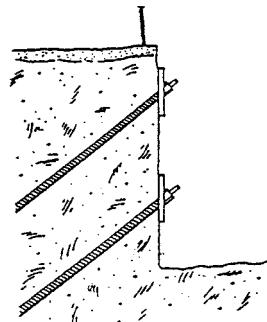

Source: WorkCover (2000)

Figure 6.4f: Rock bolts

WorkCover NSW (2000) *Code of Practice – Excavation* provides further information on the procedures to follow when contemplating or planning excavation work.

WorkCover NSW (2006) *Code of Practice – Tunnels Under Construction* provides information and procedures specifically relevant to tunnel construction but which also includes information that has relevance for works that may affect tunnels.

6.7 TYPICAL SITE DEMOLITION, CONSTRUCTION AND POST CONSTRUCTION ISSUES

A key aspect to preventing adverse effects associated with building or excavations adjacent to rail corridors and busy roads is appropriate attention to practices during the construction and post construction phases. This includes the application of best practice by the contractor undertaking the work and also adequate and suitably qualified supervision by the proponent.

Once the specific soil and rock types present at the site are identified, the key geotechnical constraints must be determined and decisions made about whether the excavation and earthworks management measures (as identified above) will be sufficient to prevent and minimise any potential impacts. Although the potential impacts are dependent on the particular geotechnical site conditions and the specific nature of the proposed development, the proponent must demonstrate that any impact on the road/rail infrastructure from the excavation or other earthworks will be within acceptable limits.

Where changes to the geotechnical conditions become apparent during the actual excavation works such as the presence of unexpected rock defects (e.g. steep interbedded strata, joints, faults, dykes) or groundwater seepages, work should cease immediately and additional geotechnical advice sought.

It is also important that the issues identified during the design process have been adequately implemented and are being maintained (eg drains, corrosion protection systems etc.). Conditions may change with time and additional measures may need to be identified and implemented.

6.7.1 Excavations and earthworks

Sites in areas of known ground instability should be identified and managed as 'special locations' from the initial stages of the proposed development.

During the construction phase of a project within or adjoining the road/rail corridor or above an existing tunnel, scheduled excavations and earthworks inspections should be undertaken on a regular basis, with particular attention to 'special locations'. There should also be a suitable monitoring program as an integral part of these inspections.

Inspections should note excavations and earthworks defects and conditions that may affect, or indicate problems including:

- Slippage, slumping, settlement or heaving.
- Fissures or cracks in excavations, earthworks or batters.
- Rock, earth or other fallen debris near the road/rail track.
- Changes to track geometry.
- Subsidence due to ground movements.
- Earthwork scour and/or erosion including loss of track ballast, undercutting of the toe of embankments or cuttings.
- Water seepage from new excavations, earthworks or from existing features such as embankments and cuttings.
- Damage to embankments or cuttings including that caused by construction or vehicle access.
- Condition of drainage systems to ensure that they are working satisfactorily and are not fully or partially blocked.
- Conditions that may cause future slip, scour, slump or settlement such as due to clearing vegetation from steep embankments and other slopes.
- Any other occurrence likely to affect the stability of excavations and earthworks.

6.7.2 Excavation support systems

It is a legal requirement under OH&S legislation that excavation works must be inspected prior to the commencement of work and at regular intervals to ensure that the excavation and its supporting systems are safe, stable and functioning appropriately (WorkCover 2000). The assessment of risk should be reviewed after any collapses or falls of material, after adverse weather or after any blasting.

All inspections of support systems should take into account the following:

- Stability, security and functionality of the retention and support systems.
- Angle of any batters remain appropriate to prevent slope failure or collapse.
- Any evidence of undercutting of the excavation.
- Appearance of any fissures or cracks in excavation sides or edges.
- Evidence of any soil or rock or other fallen debris in the excavation.
- Water seepage from excavation walls.
- Changes to soil or weather conditions.
- Extra loading.
- Surface water or run-off entering the excavation or accumulating on the ground surface close to the excavation.
- Geotechnical conditions as the excavation proceeds, particularly any unforeseen occurrences such as evidence of inclined bedding planes, floor heave (swelling), or any subsidence adjacent to the excavation.
- Appropriate timing of the removal of any support systems (i.e. not removed prematurely).
- Work practices ensure workers remain under the protection of support systems (i.e. they do not venture into unprotected and dangerous areas).
- Presence of any fumes, gases, asbestos, silica dust or other contaminants.

6.7.3 Structures

Structures adjoining rail corridor/busy roads or located above a road/rail tunnel should have a program of scheduled inspections associated with them to ensure that the integrity of the infrastructure is maintained:

All inspections of structures should take into account the following:

- Defects or changes in the structural integrity of components including cracking and movement to footings or foundations
- Any component damage caused by vandalism or other incident within the transport corridor
- Water seepage
- Retaining wall drainage systems
- Evidence of electrolysis
- Continuing compliance with implementing design requirements associated with walkways, balconies and windows which directly face the corridor (ie. any subsequent alterations, additions or renovations should also comply with the clearance and design requirements) (refer section 3).

Unscheduled inspections, particularly at locations with known site instability or other potential constraints, should also be conducted from time to time where there is a particular history of problems or after extreme events (eg high intensity rainfall).

Once construction has been completed general inspections should be scheduled at intervals specific to the conditions at the particular location but generally not exceeding 12 months duration.

6.7.4 Rail track closure and power outages

In some instances, certain phases of proposed construction or excavation may require the rail authority to stop trains running on adjoining tracks (track possession) and/or the shutting of power to rail facilities (power outage). Refer to section 5.13 for further information.

6.7.5 Demolition

Many of the issues discussed under 6.7.1 and 6.7.2 also apply to demolition as a particular aspect of the construction process.

A methodology should be developed and included with the development application where demolition is proposed adjoining the the rail corridor. This should demonstrate how impacts on the rail corridor will be avoided or mitigated

Appendix A: Sample Rail Corridor Conditions

APPLICATION

The Infrastructure SEPP requires the following development to consult with and obtain concurrence from the rail authority:

Clause 84: Development that involves:

- A new level crossing, or
- The conversion into a public road of a private access road across a level crossing, or
- A likely significant increase in the total number of vehicles or the number of trucks using a level crossing that is in the vicinity of the development

Clause 86: Development (other than development referred to in clause 88 of the *Infrastructure SEPP*¹) that involves penetration of the ground to a depth of at least 2m below ground level (existing) on land that is:

- Within or above a rail corridor, or
- Within 25 metres (measured horizontally) of a rail corridor, or
- Within 25 metres (measured horizontally) of the ground directly above an underground rail corridor.

Clause 88: Development:

- Within or adjacent to the Interim Metropolitan Rail Expansion Corridors² – see SEPP

SPECIFIC RAILWAY AUTHORITY CONCURRENCE REQUIREMENTS

Matters specified in the Infrastructure SEPP

Where concurrence is required, the consent authority must forward the development application and supporting information to the rail authority. The rail authority when deciding to grant concurrence must take into account the matters listed in the *Infrastructure SEPP* as shown in **Table A.1**.

Assessment and determination process

The rail authority can grant concurrence with or without conditions or it can refuse concurrence.

If concurrence is granted and the consent authority decides to approve the development application, it would include the conditions as nominated by the rail authority in the development consent. Potential conditions of concurrence from the rail authority that a council would then impose as a consent condition are identified below.

1 Development within or adjacent to Interim Metropolitan Rail Expansion Corridors – refer to *Infrastructure SEPP* for specific details
2 Refer to Clause 88 of the *Infrastructure SEPP* for specific requirements and definitions of these corridors

Table A1: Matters prescribed in the Infrastructure SEPP that must be taken into account by the consent authority and the rail authority

Category of development and relevant clause in the Infrastructure SEPP	Matters to be taken into account by the consent authority before determining a development application	Matters to be taken into account by the rail authority before determining whether to provide concurrence
<p>Clause 84 – <i>Development involving access via level crossings</i></p>	<ul style="list-style-type: none"> • the implications of the development for traffic safety including the costs of ensuring an appropriate level of safety having regard to existing traffic and any likely change in traffic at level crossings as a result of the development, and • the feasibility of access for the development that does not involve use of level crossings. 	<ul style="list-style-type: none"> • any rail safety or operational issues associated with the aspects of the development, and • the implications of the development for traffic safety including the costs of ensuring an appropriate level of safety having regard to existing traffic and any likely change in traffic at level crossings as a result of the development.
<p>Clause 86 – <i>Excavation in, above or adjacent to rail corridors</i></p>	<ul style="list-style-type: none"> • these guidelines; • any response from the rail authority. 	<ul style="list-style-type: none"> • The potential effects of the development (whether alone or cumulatively with other development or proposed development) on: <ul style="list-style-type: none"> – the safety or structural integrity of existing or proposed rail infrastructure facilities in the rail corridor, and – the safe and effective operation of existing or proposed rail infrastructure facilities in the rail corridor. • What measures are proposed, or could reasonably be taken, to avoid or minimise those potential effects.
<p>Clause 88 – <i>Development within or adjacent to Interim Metropolitan Rail Expansion Corridors</i></p>	<ul style="list-style-type: none"> • any response from the rail authority. 	<ul style="list-style-type: none"> • The practicability and cost of carrying out rail expansion projects on the land in the future, and <ul style="list-style-type: none"> – without limiting the above practicability and cost requirement, the structural integrity or safety of, or ability to operate, such a project, and – without limiting the above practicability and cost requirement, the land acquisition costs and the costs of construction, operation or maintenance of such a project.

POST APPROVAL COMPLIANCE

If the development is approved, the consent conditions (including conditions of concurrence) would determine the ongoing role of the rail authority and consent authority/principal certifying authority in checking the development is designed and constructed in accordance with the approval.

Potential conditions of consent relating to rail corridors

Potential conditions of consent relevant to the rail-related clauses in the *Infrastructure SEPP (cl 84, 86, 88)* are provided below as a general guide so that proponents are aware upfront of the scope of what may be required, depending on the proposal.

Each development will be assessed on its merits. Not all potential conditions listed will be applied to a development and those listed are indicative and may be subject to change, depending on the details of what is proposed.

Potential conditions may be applied to cover:

- Title search and survey
- Services search
- Dilapidation survey
- Derailment protection
- Demolition and construction impacts
- Crane and aerial operations
- Drainage
- Access to the rail corridor
- Maintenance

Title Search and Survey	<p>Prior to the issue of a Construction Certificate the applicant shall submit current property title information and an accurate survey plan of the subject site to the Rail Authority. The survey plan shall be prepared by a registered surveyor and contain all encumbrances (eg easements and right of ways) benefiting the Rail Authority, and the location of the proposed building in relation to the rail corridor.</p> <p>The Principal Certifying Authority shall not issue the Construction Certificate until written confirmation has been received from the Rail Authority confirming that this condition has been satisfied.</p> <p><i>(Note: this condition only applies where this information has not already been submitted with the Development Application. Updated survey information maybe required if the development has changed since the initial survey information was provided).</i></p>
Services Search	<p>Prior to the issue of a Construction Certificate the applicant shall request a service search from the Rail Authority to establish the existence and location of any rail services. Where rail services are identified within the rail corridor in close proximity to the subject development site, the Applicant must ensure that all required clearances (eg electrical clearances) are observed at all times during the undertaking of works. Where rail services are identified within the subject development site the Applicant must discuss with the Rail Authority as to whether these services are to be relocated or incorporated within the development site.</p> <p>The Principal Certifying Authority shall not issue the Construction Certificate until written confirmation has been received from the Rail Authority confirming that this condition/s has been satisfied.</p> <p><i>(Note: the works component of this condition cannot be satisfied until the construction certificate has been issued).</i></p>
Dilapidation Survey	<p>Prior to the issue of a Construction Certificate and prior to the issue of the Occupation Certificate, a joint inspection of the rail infrastructure and property in the vicinity of the project is to be carried out by representatives from the Rail Authority and the Applicant. The submission of dilapidation surveys for all rail infrastructure and all works in the rail corridor will be required unless otherwise notified by the Rail Authority. These dilapidation surveys will establish the extent of any existing damage and enable any deterioration during construction to be observed. The Principal Certifying Authority shall not issue the Construction Certificate or Occupation Certificate until written confirmation has been received from the Rail Authority confirming that this condition/s has been satisfied.</p>
Derailment Protection	<p>The development must be designed and constructed in accordance with the requirements of Australian Standard AS5100-2004 – <i>Bridge Design</i> and complying with clause 10.4.3 of AS5100. Prior to the issue of a Construction Certificate the Applicant is to provide the Rail Authority with a report from a qualified structural engineer demonstrating that the structural design of the development satisfies the requirements of this condition. The Principal Certifying Authority shall not issue the Construction Certificate until it has received written confirmation from the Rail Authority confirming that this report has been prepared to its satisfaction. The Principal Certifying Authority shall not issue the Construction Certificate until it has confirmed that these measures recommended in this report are to be incorporated and have been indicated on the Construction Drawings.</p>

<p>Demolition and Construction Impacts</p>	<p>Prior to the issue of a Construction Certificate a Risk Assessment / Management Plan and detailed Safe Work Method Statements (SWMS) for the proposed works are to be submitted to the Rail Authority for review and comment. The Principal Certifying Authority shall not issue the Construction Certificate until written confirmation has been received from the Rail Authority confirming that this condition/s has been satisfied.</p> <p>No metal ladders, tapes, scaffolding and plant/machinery, or conductive material are to be used within 6 horizontal metres of any live electrical equipment. This applies to the train pantographs and 1500V catenary, contact and pull-off wires of the adjacent tracks, and to any high voltage aerial supplies within or adjacent to the rail corridor.</p>
<p>Crane and aerial operations</p>	<p>Prior to the issuing of a Construction Certificate the Applicant is to submit to the Rail Authority a plan showing all craneage and other aerial operation for the development and must comply with all requirements of the Rail Authority. The Principal Certifying Authority shall not issue the Construction Certificate until written confirmation has been satisfied.</p>
<p>Drainage</p>	<p>Drainage from the development must be adequately disposed of /managed and not allowed to be discharged into the corridor unless prior approval has been obtained from Rail Authority.</p> <p>Rainwater from the roof must not be projected and/or fall into the rail corridor and must be piped down the face of the building which faces the rail corridor.</p> <p>The Principal Certifying Authority shall not issue the Construction Certificate until it has confirmed that this condition has been complied with and drainage systems to ensure compliance with this condition have been indicated on the Construction and Drainage Drawings.</p>
<p>Access to rail corridor</p>	<p>No work or any objects relating to works are permitted within the rail corridor or the airspace above it, or its easements, at any time unless prior approval or an Agreement has been entered into with the Rail Authority.</p> <p>All works within the rail corridor are to be carried out in accordance with railway Safeworking rules and regulations, including the Network Rules and Procedures.</p> <p>Where the Applicant proposes to enter the rail corridor, the Principal Certifying Authority shall not issue a Construction Certificate until written confirmation has been received from the Rail Authority confirming that its approval has been granted.</p>
<p>Maintenance of Development</p>	<p>The proponent must provide a plan of how future maintenance of the development facing the rail corridor is to be undertaken. The maintenance plan is to be submitted to the Rail Authority prior to the issuing of the Occupation Certificate. The Principal Certifying Authority shall not issue an Occupation Certificate until written confirmation has been received from Rail Authority advising that the maintenance plan has been prepared to its satisfaction.</p>

Appendix B – Acoustic Planning Measures

This Appendix compares a hypothetical typical modern “project home” (single storey) with its noise-sensitive rooms facing a busy road, to the same home after applying “good” acoustic planning by orientating the building so that noise-sensitive rooms are on the opposite side to the busy road.

The single storey hypothetical house comprises building materials for the walls, roof and floor that are typical of a modern “project home”. Two orientations of the house are presented in Figures B1 and B2. The Appendix presents both the internal and external noise levels associated with the two orientations as well as three different building Specifications A, B and C.

NOISE MODELLING

External Noise Levels

For each orientation, external road traffic noise was modelled around each building at 1m from critical windows and doors, and the external noise modelling assumptions are set out below:

- using an assumed high traffic noise level of 68dB(A) LAeq for day and night at 1m from the facade most affected by traffic noise, all other external results are established at 1m from each critical building element and are presented in units of A-weighted decibels, dB(A)
- model uses the Calculation of Road Traffic Noise (CoRTN), 1988 algorithms
- three source heights (0.5m, 1.5m and 3.6m)
- flat ground was between the road and the receiver point
- receiver height at 1.5m above ground
- no barriers or shielding between the road and the receiver point
- 160 degrees angle of view of road from receiver point
- no gradient on road
- facade correction of +2.5dB(A)
- ARRB correction of -1.7dB(A) for Australian conditions
- the same size buildings exist on each adjacent side of the subject property with a separation of 2m to the common boundary (ie 4m spacing between adjacent buildings) to account for shielding of road noise typically provided by buildings adjacent to developments.

Internal Noise Levels

To calculate the internal noise levels and estimate potential savings from applying “good” acoustic planning principles, building specifications used were determined for each building element of each orientation. The selection of building specifications required was based on achieving the internal noise goals set out in the Infrastructure SEPP, being LAeq 35dB(A) for bedrooms and 40dB(A) for other habitable areas. Each building specification is matched with a noise calculation Scenario, eg. Scenario A uses Specification A, and Scenario B uses Specification B etc.

In-principle cost estimates are included to allow cost comparisons and estimates of potential cost savings when using good acoustic planning principles.

The assumptions made in the internal noise modelling are as follows:

- typical layout of a modern dwelling taken from a recent large residential development in an outer Sydney suburb
- assumed reverberation time of 0.6 seconds for bedrooms and 1.0 second for other habitable rooms
- the relevant dimensions of the each room are as follows in **Table B1**.

Table B1: Assumed Room Volumes and Areas

Rooms	Volumes & Areas
Bedroom 1	
Volume (3W x 3L x 2.7H)	24.3m ³
Window (1.2W x 1.5H)	1.8m ²
Wall [(3W x 2.7H) – (window area)]	6.3m ²
Roof / Ceiling Area (3W x 3L)	9m ²
Floor Area (3W x 3L)	9m ²
Bedroom 2	
Volume (3W x 4L x 2.7H)	32.4m ³
Window Area - side (2W x 2.2H)	4.4m ²
Wall Area – side [(4W x 2.7H) – (window area)]	6.4m ²
Window Area – front/back (1.5W x 1.8H)	2.7m ²
Wall Area – front/back [(3W x 2.7H) – (window area)]	5.4m ²
Roof / Ceiling (3W x 4L)	12m ²
Floor (3W x 4L)	12m ²
Bedroom 3	
Volume (3W x 4L x 2.7H)	32.4m ³
Window - side (1.5W x 1.8H)	2.7m ²
Wall Area – side (3W x 2.7H – window area)	5.4m ²
Window – front/back (1.5W x 1.8H)	2.7m ²
Wall Area – front/back (4W x 2.7H – window area)	8.1m ²
Roof / Ceiling (3W x 4L)	12m ²
Floor (3W x 4L)	12m ²
Lounge	
Volume (6W x 6L x 2.7H)	97.2m ³
Glass Sliding Door (2W x 2.2H)	4.4m ²
Wall Area – side [(6W x 2.7H) – (window area)]	11.8m ²
Window - return (1.5W x 1.8H)	2.7m ²
Wall Area – return [(3W x 2.7H) – (window area)]	5.4m ²
Timber Door – front/back (1.2W x 2H)	2.4m ²
Wall Area – front/back [(4W x 2.7H) – (door area)]	8.4m ²
Roof / Ceiling (6W x 6L)	36m ²
Floor (6W x 6L)	36m ²
Kitchen / Dining room	
Volume (6W x 4L x 2.7H)	64.8m ³
Glass Sliding Door - dining area (2W x 2.2H)	4.4m ²
Window - kitchen area (0.8W x 1.2H)	1m ²
Wall [(6W x 2.7H) – (window areas)]	10.8m ²
Roof/ Ceiling (6W x 4L)	24m ²
Floor (6W x 4L)	24m ²

ORIENTATIONS

The two orientations of the house in **Figures B1** and **B2** are:

Orientation 1 (Figure B1)

The “Project home” is shown with bedrooms and other rooms located at the further most points from the road. Shielding is provided to the bedrooms by less sensitive rooms of the house.

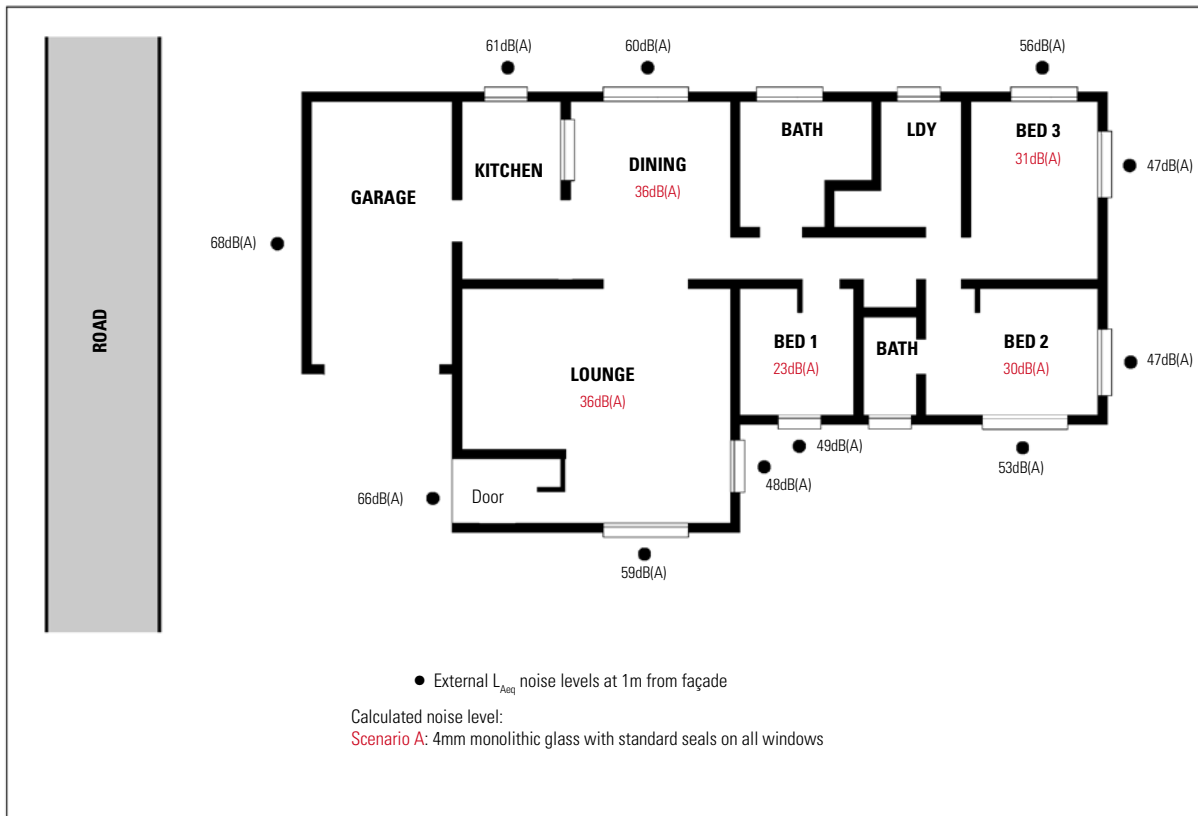

Figure B1

BUILDING SPECIFICATIONS

The specifications of critical building materials used are listed below.

Specification A

Windows	standard 4mm monolithic glass with standard weather seals on all windows	(Rw 25)
Doors	30mm solid core timber – lounge room aluminium framed glass sliding door – lounge and dining rooms	(Rw 24)
Walls	brick-veneer and standard plasterboard on timber studs with insulation in cavity	(Rw 52)
Roof	tiled roof and standard plasterboard ceiling with insulation	(Rw 43)
Floor	concrete slab	

Note: 'Rw' is the weighted sound reduction index of a building element

Orientation 2 (Figure B2)

The “Project home” is shown with bedrooms on the end of the house most exposed to the road.

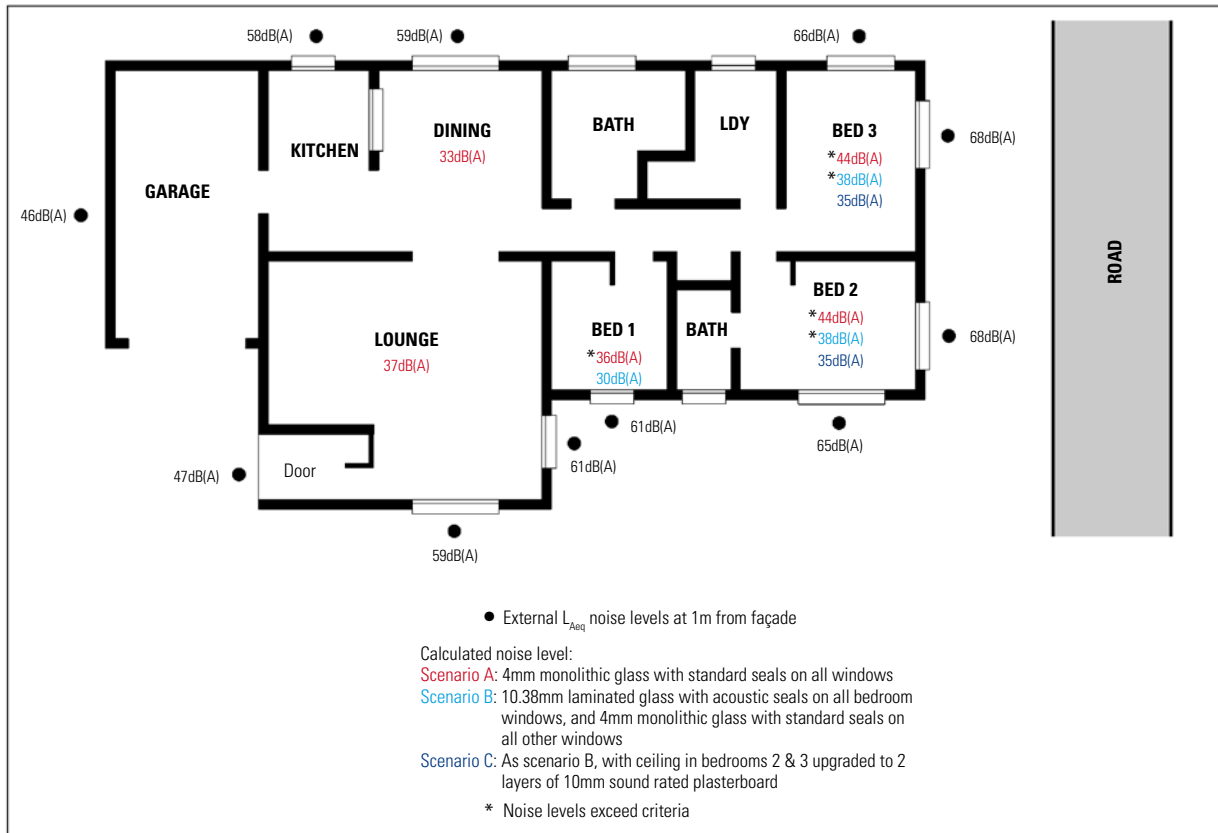

Figure B2

Specification B

Windows	10.38mm laminated glass with acoustic seals on all bedroom windows, standard 4mm monolithic glass with standard seals on all other windows	(Rw 35)
Doors	30mm solid core timber – lounge room aluminium framed glass sliding door – lounge and dining rooms	(Rw 24)
Walls	brick-veneer and standard plasterboard on timber studs with insulation in cavity	(Rw 52)
Roof	tiled roof and standard plasterboard ceiling with insulation	(Rw 43)
Floor	concrete slab	

Note: 'Rw' is the weighted sound reduction index of a building element

Specification C

Windows	10.38mm laminated glass with acoustic seals on all bedroom windows, standard 4mm monolithic glass with standard seals on all other windows	(Rw 35)
Doors	30mm solid core timber – lounge room aluminium framed glass sliding door – lounge and dining rooms	(Rw 24)
Walls	brick-veneer and standard plasterboard on timber studs with insulation in cavity	(Rw 52)
Roof	as per Specification B, except the single layer of standard plasterboard ceiling is replaced with a double-layer of 10mm sound-rated plasterboard ceiling	(Rw 52)
Floor	concrete slab	

Note: 'Rw' is the weighted sound reduction index of a building element

INTERNAL NOISE MODELLING RESULTS

Orientation 1 – Project Home with Bedrooms Away from Busy Road

Figure B1 contains the calculated internal noise levels for each bedroom, the lounge and kitchen/dining room when the house is oriented with the road away from the bedrooms. The internal noise levels presented are the results of Scenario A only (in 'red'), as noise levels were not found to exceed the Infrastructure SEPP noise limits in any of the rooms. Otherwise Scenarios B and C would have been calculated.

This illustrates that orientating or positioning noise sensitive rooms such as bedrooms away from a busy road, can have acoustic benefits.

Orientation 2 – Project Home with Bedrooms Facing Busy Road

Figure B2 contains the calculated internal noise levels for each bedroom, the lounge and kitchen/dining room when the house is oriented with the road facing the bedrooms. The internal noise levels presented are the results of Scenario A (in 'red'), Scenario B (in 'blue') and Scenario C (in 'purple'). Only the rooms found to exceed the Infrastructure SEPP noise limits were progressed to the calculations for Scenarios B and C, and these were all three bedrooms for Scenario B and only bedrooms 2 and 3 for Scenario C.

The 'bold' internal noise levels indicate levels exceeding the Infrastructure SEPP noise limits.

COST ESTIMATE RESULTS

Cost estimates are provided for each of the two orientations and for each of the three building specifications, as necessary. The cost rates adopted are considered to be averages, applicable in the Sydney metropolitan area, for normal residential projects, as at June 2008. The cost estimate results are presented at the end of Appendix B.

In summary, a cost difference of \$ 4,076.50, was found between the two orientations which represents approximately 10% of the total building elements considered.

This illustrates the potential cost savings when good acoustic planning and design measures are used.

Comparative Cost Estimates for orientations 1 and 2 and specifications A–C:

Ref	Description	Qty	Unit	Specification	Orientation 1		Orientation 2		
					Rate	Total	Specification	Rate	Total
Bed 1									
1	Window	1.8	m ²	A	325	585.00	B	500	900.00
2	Wall	6.3	m ²	A	250	1,575.00	A	250	1,575.00
3	Ceiling	9	m ²	A	60	540.00	A	60	540.00
Bed 2									
1	Window	2.7	m ²	A	325	877.50	B	500	1,350.00
2	Wall	5.4	m ²	A	250	1,350.00	A	250	1,350.00
3	Side window	4.4	m ²	A	325	1,430.00	B	500	2,200.00
4	Side wall	6.4	m ²	A	250	1,600.00	A	250	1,600.00
5	Ceiling	12	m ²	A	60	720.00	C	90	1,080.00
Bed 3									
1	Window	2.7	m ²	A	325	877.50	B	500	1,350.00
2	Wall	8.1	m ²	A	250	2,025.00	A	250	2,025.00
3	Side window	2.7	m ²	A	325	877.50	B	500	1,350.00
4	Side wall	5.4	m ²	A	250	1,350.00	A	250	1,350.00
5	Ceiling	36	m ²	A	60	720.00	C	90	1,080.00
Lounge									
1	Entry door	2.4	m ²	A	400	960.00	A	400	960.00
2	Wall	8.4	m ²	A	250	2,100.00	A	250	2,100.00
3	Sliding glass doors	4.4	m ²	A	300	1,320.00	A	300	1,320.00
4	Side wall	11.8	m ²	A	250	2,950.00	A	250	2,950.00
5	Window	2.7	m ²	A	325	877.50	A	325	877.50
6	Return wall	5.4	m ²	A	250	1,350.00	A	250	1,350.00
7	Ceiling	36	m ²	A	60	2,160.00	A	60	2,160.00
Kitchen/Dining									
1	Window	1	m ²	A	325	325.00	A	325	325.00
2	Sliding glass doors	4.4	m ²	A	300	1,320.00	A	300	1,320.00
3	Wall	10.8	m ²	A	250	2,700.00	A	250	2,700.00
4	Ceiling	24	m ²	A	60	1,440.00	A	60	1,440.00
Sub-total						\$32,030.00			\$35,252.50
Builders OH&P 15%						\$4,804.50			\$5,287.88
GST 10%						\$3,683.45			\$4,054.04
Totals						\$40,517.95			\$44,594.41

Note: Component areas and all acoustic calculations and specifications provided by Renzo Tonijn & Associates. Costings by BDA Consultants Pty Ltd. Rates adopted are considered to be averages, applicable in the Sydney metropolitan area for standard residential projects as of June 2008.

The cost difference between the house configurations and treatments in Fig B1 and Fig B2 of \$4,076.50 represents approximately 10% of the total building elements considered above and over 60% of the particular elements affected in this example. It well illustrates the possible cost savings of designing the housing layout so that the bedrooms are located away from the noise source.

Appendix C – Acoustic Treatment of Residences









The following table sets out standard (or deemed-to-satisfy) constructions for each category of noise control treatment for the sleeping areas and other habitable areas of single / dual occupancy residential developments only. The assumptions made in the noise modelling are as follows:



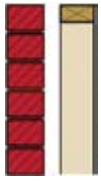

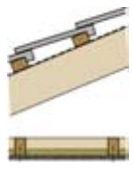

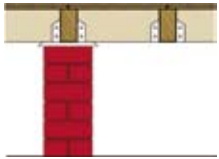
- Typical layout of a modern dwelling taken from a recent large residential development in an outer Sydney suburb
- Bedrooms and other habitable rooms are exposed to road noise



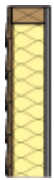
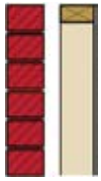

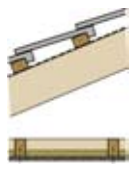
ACOUSTIC PERFORMANCE OF BUILDING ELEMENTS

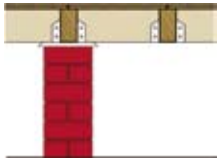



The acoustic performances assumed of each building element in deriving the Standard Constructions for each category of noise control treatment presented in the preceding Table, are presented below in terms of Weighted Sound Reduction Index (R_w) values, which can be used to find alternatives to the standard constructions presented in this Appendix:

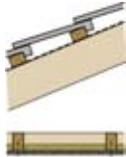

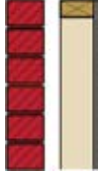

Category of Noise Control Treatment	R_w of Building Elements (minimum assumed)				
	Windows/Sliding Doors	Frontage Facade	Roof	Entry Door	Floor
Category 1	24	38	40	28	29
Category 2	27	45	43	30	29
Category 3	32	52	48	33	50
Category 4	35	55	52	33	50
Category 5	43	55	55	40	50

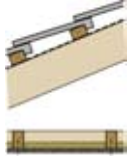
Category No.	Building Element	Standard Constructions	sample
1	Windows/Sliding Doors	Openable with minimum 4mm monolithic glass and standard weather seals	
	Frontage Facade	Timber Frame or Cladding: 6mm fibre cement sheeting or weatherboards or plank cladding externally, 90mm deep timber stud or 92mm metal stud, 13mm standard plasterboard internally	
		Brick Veneer: 110mm brick, 90mm timber stud or 92mm metal stud, minimum 50mm clearance between masonry and stud frame, 10mm standard plasterboard internally	
		Double Brick Cavity: 2 leaves of 110mm brickwork separated by 50mm gap	
	Roof	Pitched concrete or terracotta tile or metal sheet roof with sarking, 10mm plasterboard ceiling fixed to ceiling joists, R1.5 insulation batts in roof cavity.	
	Entry Door	35mm solid core timber door fitted with full perimeter acoustic seals	
	Floor	1 layer of 19mm structural floor boards, timber joist on piers	
Concrete slab floor on ground			

Category No.	Building Element	Standard Constructions	sample
2	Windows/Sliding Doors	Openable with minimum 6mm monolithic glass and full perimeter acoustic seals	
	Frontage Facade	Timber Frame or Cladding Construction: 6mm fibre cement sheeting or weatherboards or plank cladding externally, 90mm deep timber stud or 92mm metal stud, 13mm standard plasterboard internally with R2 insulation in wall cavity.	
		Brick Veneer Construction: 110mm brick, 90mm timber stud frame or 92mm metal stud, minimum 50mm clearance between masonry and stud frame, 10mm standard plasterboard internally.	
		Double Brick Cavity Construction: 2 leaves of 110mm brickwork separated by 50mm gap	
	Roof	Pitched concrete or terracotta tile or metal sheet roof with sarking, 10mm plasterboard ceiling fixed to ceiling joists, R2 insulation batts in roof cavity.	
	Entry Door	40mm solid core timber door fitted with full perimeter acoustic seals	
	Floor	1 layer of 19mm structural floor boards, timber joist on piers	
Concrete slab floor on ground			

Category No.	Building Element	Standard Constructions	sample
3	Windows/Sliding Doors	Openable with minimum 6.38mm laminated glass and full perimeter acoustic seals	
	Frontage Facade	Brick Veneer Construction: 110mm brick, 90mm timber stud or 92mm metal stud, minimum 50mm clearance between masonry and stud frame, 10mm standard plasterboard internally.	
		Double Brick Cavity Construction: 2 leaves of 110mm brickwork separated by 50mm gap	
	Roof	Pitched concrete or terracotta tile or sheet metal roof with sarking, 1 layer of 13mm sound-rated plasterboard fixed to ceiling joists, R2 insulation batts in roof cavity.	
	Entry Door	45mm solid core timber door fitted with full perimeter acoustic seals	
	Floor	Concrete slab floor on ground	

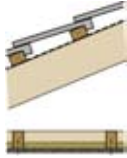
Category No.	Building Element	Standard Constructions	sample
4	Windows/Sliding Doors	Openable with minimum 10.38mm laminated glass and full perimeter acoustic seals	
	Frontage Facade	Brick Veneer Construction: 110mm brick, 90mm timber stud or 92mm metal stud, minimum 50mm clearance between masonry and stud frame, R2 insulation batts in wall cavity, 10mm standard plasterboard internally.	
		Double Brick Cavity Construction: 2 leaves of 110mm brickwork separated by 50mm gap	
	Roof	Pitched concrete or terracotta tile or sheet metal roof with sarking, 2 layers of 10mm sound-rated plasterboard fixed to ceiling joists, R2 insulation batts in roof cavity.	
	Entry Door	45mm solid core timber door fitted with full perimeter acoustic seals	
	Floor	Concrete slab floor on ground	

Category No.	Building Element	Standard Constructions	sample
5	Windows/Sliding Doors	Openable Double Glazing with separate panes: 5mm monolithic glass, 100mm air gap, 5mm monolithic glass with full perimeter acoustic seals.	
	Frontage Facade	Double Brick Cavity Construction: 2 leaves of 110mm brickwork separated by 50mm gap with cement render to the external face of the wall and cement render or 13mm plasterboard direct fixed to internal faces of the wall.	
	Roof	Pitched concrete or terracotta tile or sheet metal roof with sarking, 2 layers of 10mm sound-rated plasterboard fixed to ceiling joist using resilient mounts, R2 insulation batts in roof cavity	
	Entry Door	Special high performance acoustic door required - Consult an Acoustic Engineer	<i>Door to acoustic consultant's specifications</i>
	Floor	Concrete slab floor on ground	
6	All	Consult an Acoustic Engineer	

Appendix D – Acoustic Consultant Reports, Methodology for Testing and Compliance Reporting

The following outlines the matters to be included in an acoustic assessment with relevant matters reported in the assessment report to accompany the development application:

RAIL CORRIDORS

- a The noise and vibration source:
 - i) outline of the relevant characteristics of railway activities, including reference to special characteristics such as curve squeal, wagon bunching, steel bridges, high speed operators or powering/braking on gradient;
 - ii) consideration of day time and night time activities;
 - iii) consideration of future railway proposals;
- b The proposed development:
 - i) the proposed use and its level of sensitivity to noise and vibrations - recording studios are likely be more sensitive than cinemas, microelectronics manufacturers are likely to be more sensitive than computer facilities, daycare sleeping areas may be more sensitive than play areas; hotel or residential apartments will be more sensitive than commercial offices.
 - ii) outline of the characteristics of the site that are relevant in respect of noise and vibration propagation such as cuttings, embankments, ground type
 - iii) outline the proposed layout and design of the development with a site plan and plans providing the building layout and details of key structural and other design characteristics with implications for noise or vibration impacts

- c Baseline noise or vibration levels taking into consideration tonality, frequency, time of day including a plan showing the location any monitoring sites used in the assessment
- d Details of outcomes of the modelling taking into consideration levels, tonality, frequency and time of day with prediction of the likely noise and vibration impacts levels for both external and internal. This includes providing details of the calculation methodologies used in the assessment and discussion of the extent to which any relevant noise and vibration assessment criteria are met;
- e Outline of proposed mitigation measures and discussion of the likely effectiveness
- f Discussion of the likely acceptability of outcomes.
- g The criteria used in the assessment.

When train noise measurements are undertaken to determine the current noise levels, the characteristics of the rail operations at that location should be taken into account when determining the type, and number of measurements required. For example, where night-time freight operations occur, it is not sufficient to measure only daytime passenger train noise levels.

For all train noise level measurements, the date and time of the event should be recorded, along with the approximate passby speed, train type, number of carriages, and any audible characteristics (such as wheel flats, flanging etc.). When estimating the LAeq(15h) for daytime and the LAeq(9h) noise levels for night-time, the energy averaged LAE value from the measurements should be used in the calculations.

Whilst long term monitoring is always preferable, in many situations it may be reasonable and justifiable to measure a minimum of 20 train pass-by events to

obtain a representative sample. Furthermore where train movements are infrequent, a measurement period that includes a 'peak noise' period may also be justifiable.

Where night-time freight is a concern, measurements should be undertaken over a period of at least one night (10pm – 7am). The freight train timetable if available should be used to determining the most appropriate measurement period.

BUSY ROADS

The report should include the following information as a minimum:

A brief description of the project;

A brief description of the existing noise environment;

A site plan showing the location of noise monitors;

Documentation of noise monitoring equipment and procedures including:

- Location of noise monitors including distance to road
- Site photographs identifying the noise monitor and its position
- Type of instrument used
- Results of field calibration checks

Noise monitoring results including:

- Sample times and measurement intervals
- Weather conditions during measurement
- Traffic conditions during measurement
- Adjustments for nearby reflecting surfaces
- Description of sources other than traffic (eg aircraft, trains, dogs barking, etc.) and how these might have affected the results.
- A table summarising the measured noise levels
- Graphical presentation of monitored noise levels using 15-minute intervals and including the LA_{max} (or LA1), L_{Aeq} and LA90 noise parameters
- Methodology for determining existing noise levels at locations other than those monitored

Existing traffic volume;

Explanation of indoor/outdoor noise criteria used and why it is appropriate;

Noise model information including:

- A description of the noise model and algorithms used in prediction modelling
- The parameters used in the model (eg traffic volumes and percentage of heavy vehicles, vehicle speed, pavement surface, gradient of roadway, receiver heights, ground cover, inclusion of noise mounds or barriers, reflections from buildings and barriers)
- Verification of the noise model to demonstrate that the model is capable of generating accurate outputs

Noise prediction results including:

- A table summarising existing noise levels and future predicted noise levels
- Statements quantifying any adjustments made to the predicted noise levels for the purpose of assessment
- Comparison of predicted noise levels against noise goals

A description of proposed noise mitigation measures for the development that will achieve the set noise criteria including:

- Explanation of noise mitigation used to achieve outdoor noise goals
- Explanation of noise mitigation used to achieve indoor noise goals
- Statement of limitations of noise mitigation treatments and, if applicable, explanation of why some treatments may not be reasonable, feasible, or cost effective.

COMPLIANCE

Reporting

At Construction Certificate stage, it is recommended that there should be signoff to confirm that appropriate noise mitigation measures have been integrated into the development design. In cases where a full noise assessment has been undertaken, the acoustic consultant may need to document how the appropriate noise and vibration criteria will be met. During construction, it is recommended that all acoustic treatments nominated in the acoustic report and other project documentation shall be implemented.

It is recommended that there should be a sign-off at the Occupation Certificate stage to confirm that the building has been constructed in accordance with any acoustic conditions in the development consent and the conditions of development consent and that the post-construction noise measurements, where applicable, comply with the relevant criteria. In hot spot noise areas, a measurement report from a qualified acoustic consultant may be required to demonstrate compliance with the noise criteria prior to issuing the Occupation Certificate.

Methodology for compliance measurements

In order to establish compliance with the daytime and night-time internal noise levels, the noise reduction from outside to inside shall be determined and the internal noise level normalised with reference to the long-term external measurements using the following methodology.

The following noise measurement techniques are to be followed:

- Internal measurement locations shall be in the centre of the room, 1.2-1.5 metres above floor level and at least 1 metre from any reflecting surface.
- The room condition used for testing shall be fully furnished, or where this is not practical, any corrections to the resultant noise levels (i.e. for more reverberant conditions) shall be justified.
- The long-term monitoring instrument shall remain in operation in the same location during all internal measurements.
- Where similar room layouts, relationship to rail corridor/roadway, and acoustic designs have been implemented into multi-level residential dwellings, at least two bedrooms and two other habitable rooms (where applicable) for each different acoustic design scenario shall be tested for compliance. These rooms shall be selected to represent the worst-case for each scenario (ie where the same glazing treatment has been applied to say three levels of a residential apartment development, only two bedrooms and two other habitable rooms need to be tested and these should be those worst affected by traffic noise).

Methodology for compliance reporting

The compliance report prepared shall provide the following information as a minimum:

- A brief description of the project;
- A brief description of the existing noise environment and other noise sources that may affect the measurement results. Any adjustment to measured levels for extraneous noise shall be justified;
- A site plan showing the location of noise monitors and rooms tested. Justification of the selected test rooms;
- Documentation of noise monitoring equipment and procedures including:
- Location of noise monitors including distance to road
- Site photographs identifying the noise monitor and its position
- Type of instrument used
- Results of field calibration checks
- Noise monitoring results including:
 - Sample times and measurement intervals
 - Weather conditions during measurement
 - Rail movements/traffic conditions during measurements
 - Adjustments for nearby reflecting surfaces
 - Description of sources other than road/rail traffic (eg. aircraft, road/trains, dogs barking, etc.) and how these might have affected the results.
 - A table summarizing the internal and external measured noise levels
 - Graphical presentation of monitored noise levels using the measured time interval
 - Methodology for determining noise reduction calculated for each test room.
 - Normalised internal measurement results in terms of the required criteria.

References

- Audible Landscape <http://www.fhwa.dot.gov/environment/comgrwth.htm>.
- Australian Design Rule 28/01 – External Noise of Motor Vehicles.
- Australian Design Rule 37/01 – Emission Control for Light Vehicles.
- Australian Design Rule 70 – Exhaust Emission Control for Diesel Engined Vehicles.
- Australian Design Rule 79/00 – Emission Control for Light Vehicles.
- Australian Design Rule 80/00 – Emission Control for Heavy Vehicles.
- Australian Rail Track Corporation (ARTC) (2005) ARTC Structures – Design Standards BDS 06 (RIC Standard; TS 30 000 3 01 SP).
- Australian Safety and Compensation Council (2006), Guidance on principles of Safe Design for Work.
- Babsich, W (2006) Transportation Noise and Cardiovascular Risk- Review and Synthesis of Epidemiological Studies, Umweltbundesamt.
- Brauer M, Gehring U, Brunekreef B, de Jongste J, Gerritsen J, Rovers M, Wichmann HE, Wijga A, Heinrich J. (2006) Traffic-related air pollution and otitis media, *Environmental Health Perspectives* 114(9):1414–8.
- Brown, A.L., Bullen, R.B. (2003), Road Traffic Noise Exposure in Australian Capital Cities, *Acoustics Australia*, Volume 31, Issue 1, pp. 11–16.
- Department of Environment and Conservation (NSW) (1999) Environmental Guidelines: Assessment, Classification and Management of Liquid and Non-liquid Wastes.
- Department of Environment and Conservation (NSW) (2005) Approved Methods and Guidance for the Modelling and Assessment of Air Pollutants in New South Wales.
- Department of Environment and Conservation (NSW) (2006) Assessing vibration: a technical guideline.
- Department of Environment and Climate Change (NSW) (2007) Interim Guideline for the Assessment of Noise from Rail Infrastructure Projects.
- Environmental Health Council (2004) The Health Effects of Environmental Noise – Other than Hearing Loss.
- Environment Protection Authority (NSW) (1999) Environmental Criteria for Road Traffic Noise – ECRTN.
- Environment Protection Authority (NSW) (2000), Industrial Noise Policy.
- Environment Protection Authority (NSW) (2004), Noise Guide for Local Government.
- Environmental Transport Association (ETA) (1997), Road user exposure to air pollution, literature review report.
- Fierro, M. A. O'Rourke, M. K. and Burgess, J. L (2001) Adverse Health Effects of Exposure to Ambient Carbon Monoxide, University of Arizona, College of Public Health.
- Franklin M, Zeka A, Schwartz J. (2007) Association between PM2.5 and all-cause and specific-cause mortality in 27 US communities, *Journal of Exposure Science & Environmental Epidemiology* 17(3): 279–87.
- Gordian ME, Haneuse S, Wakefield J. (2006) An investigation of the association between traffic exposure and the diagnosis of asthma in children, *Journal of Exposure Science & Environmental Epidemiology* 16(1):49–55.
- Hulse, B. Riesch, L. Wehnes, R. Uram, E. Gawenda, W and Ratchford, B. (2001) Highway Health Hazards In Southeast Wisconsin: How highways and roads threaten your health and what you can do about it.
- Joint Research Centre – Institute for Environment and Sustainability (2002) A European Aerosol Phenomenology – physical and chemical characteristics of particulate matter at kerbside, urban, rural and background sites in Europe.
- Krzyzanowski, Michael; Kuna-Dibbert, Birgit & Schneider, Jürgen. Eds (2005) The Health Effects of Transport-Related Air Pollution World Health Organization, Copenhagen, Denmark.
- Landcom (2004) Managing Urban Stormwater: Soils and Construction (“The Blue Book”).
- Level Crossing Strategy Council (NSW): website www.levelcrossings.nsw.gov.au
- National Environment Protection Council (2001) National Environment Protection (Diesel Vehicle Emissions) Measure (or Diesel NEPM).

National Heart Foundation of Australia (Victorian Division) (2004) *Healthy by Design: A Planners' Guide to Environments for Active Living*.

NSW Health (2004) Comparison of personal exposures to air pollutants by commuting mode in Sydney. Available at: <http://www.health.nsw.gov.au/public-health/ehb/hazards/personal.html>

Pierse N, Rushton L, Harris RS, Kuehni CE, Silverman M, Grigg J. (2006) Locally generated particulate pollution and respiratory symptoms in young children, *Thorax* 61:216–220.

RailCorp (2002) *Electrolysis from Stray DC Current*, EP 12 30 00 01 SP.

RailCorp (2005) *A Guide to Working in and around the Rail Corridor*.

Roads and Traffic Authority (RTA) (NSW) (2001) *Environmental Noise Management Manual*.

Sheppard V, Morgan G, Corbett S. (2006) NSW Indoor Air Survey. Part I: Sources and Concentrations of Pollutants in Homes in New South Wales; Part II: Concentrations of Nitrogen Dioxide in Homes in New South Wales; Part III: Particulate Matter Concentrations in Homes in New South Wales, *Environmental Health* 6(3): 15–41.

Southern Sydney Regional Organisation of Councils (2002), *External noise insulation requirements for multi-unit residential housing against road and rail noise*. Version A.

Spirn, A. W., (2004) *Better air quality at street level: strategies for urban design*, Time-Saver Standards for Urban Design, Digital Engineering Library McGraw Hill.

State Pollution Control Commission, Roads and Traffic Authority, and Department of Housing (1991) *Reducing Traffic Noise – A Guide for Homeowners, Designers and Builders*.

UNECE–WHO Transport, Health and Environment Pan–European Programme (2004), *Transport–related Health Effects with a Particular Focus on Children*, RIVM Report 815120002/2004.

Vasilovska, M (2003) *Air Quality Guidelines for Road Tunnels*, 5th Annual Tunnelling Conference.

Venn AJ, Lewis SA, Cooper M, Hubbard R, Britton J. (2001) Living near a main road and the risk of wheezing in children, *American Journal of Respiratory and Critical Care Medicine*, 164 (12) 2177–80.

WorkCover NSW (2000) *Code of Practice – Excavation*.

WorkCover NSW (2006) *Code of Practice - Tunnels under Construction*.

World Health Organisation (WHO) (2001) *Guidelines for Community Noise*.

World Health Organisation (WHO) Working Group (2000) *Quantification of the Health Effects of Exposure to Air Pollution*, Bilthoven, Netherlands.

World Health Organisation (WHO) Working Group (2003) *Health Aspects of Air Pollution with Particulate Matter, Ozone and Nitrogen Dioxide*, Bonn, Germany.

World Road Association (PIARC) (2000) *Pollution by nitrogen oxides – regulation on ventilation in road tunnels*.

Acknowledgements

These Guidelines are based on the results of several projects which have been drawn together and consolidated for both rail and road infrastructure.

Particular acknowledgement is given to the following:

Renzo Tonin & Associates (NSW) Pty Ltd
Johnson Pilton Walker Pty Ltd
Connell Wagner

Acknowledgement is also given to the following organisations and agencies, which assisted in the preparation and review of this or earlier versions of these Guidelines:

Australian Rail Track Corporation (ARTC)
BDA Consultants Pty Ltd
Heggies Pty Ltd
Landcom
Local Government and Shires Associations of NSW (LGSA)
NSW Department of Environment & Climate Change (DECC)
NSW Department of Health
NSW Department of Planning
NSW Department of Premier and Cabinet
NSW Roads and Traffic Authority (RTA)
Parsons Brinckerhoff
RailCorp
Transport Infrastructure Development Corporation (TIDC)
Wilkinson Murray Pty Ltd

